



windmill
all about fans

An Exclusive Designer Product from **TULLU** Green

Designer fan collection 2024

YOUR space YOUR choice OUR fans

We are a manufacturing company located in India, serving customers since 1947.

Our brand **TULLU** green is recognised for Quality and Performance across the country.

- + made in India
- + handmade with care
- + Major production exported worldwide
- + in-house research & development team
- + trusted by leading architects & designers
- + available worldwide through our trusted partners



HIGH TORQUE MOTOR

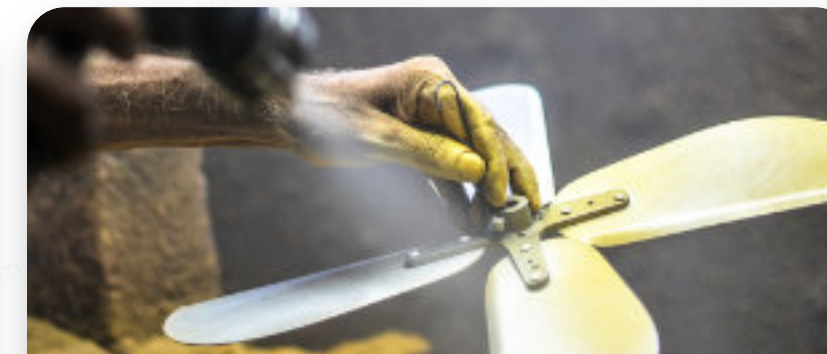

COMPLETE CUSTOMISATION



SOLID WOOD BLADES

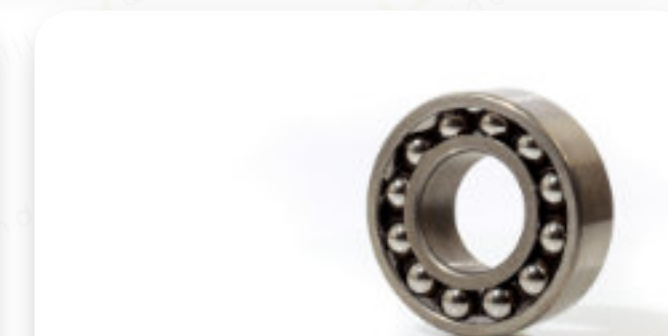

RUBBER SEALED PRECISION BEARINGS



EXPORTED WORLDWIDE



AUTOMATION COMPATIBLE

THERE
ARE MANY
REASONS
WHY
WINDMILL
FANS
ARE THE
BEST
DESIGNER
FANS.

1

ROOM SIZE



< 60 SQ.FT.

Blade Sweep
900 mm or less



60 TO 100 SQ.FT.

Blade Sweep
upto 1050 mm



100 TO 135 SQ.FT.

Blade Sweep
upto 1200 mm



135 TO 200 SQ.FT.

Blade Sweep
upto 1400 mm



> 200 SQ.FT.

Blade Sweep
1500 mm. or more
OR
multiple fans of smaller size.

2

MOUNT



HUGGER
NO DOWNROD

Ceiling height 8 feet or less



REGULAR FAN
WITH DOWNROD

Ceiling height 8.5 feet or more



REGULAR FAN
WITH ROD EXTENSION

Ceiling Height 10 feet or more



REGULAR FAN
WITH BALL MOUNTING

Sloping Mount
(max. 27 degree rake)

3

STYLE



MODERN



CONTEMPORARY



CUTTING EDGE



HERITAGE



CLASSIC

4

CUSTOMISE

STANDARD

Choose from select
fan finish combinations

2 - 3 week manufacturing lead time

No customisation charges

CUSTOMISED

Choose from our range of motor &
fan blade finishes

4 - 5 week manufacturing lead time

Customisation charges applicable

5

ROD LENGTH

1. Keep Ceiling fan between 8 to 9 feet from the Ground
2. Minimum distance between Fan blade and ceiling should be 7 inches and more for sizes larger than 1200 mm.
3. Downrod Length can be customised to any length
4. Length upto 1.5 meter in single piece
5. Length greater than 1.5 meter in multiples with jointers

FACT

Fans with longer rods have LESSER wobble.

**SELECT
THE
RIGHT
FAN FOR
YOUR
SPACE**

REVERSE FUNCTION

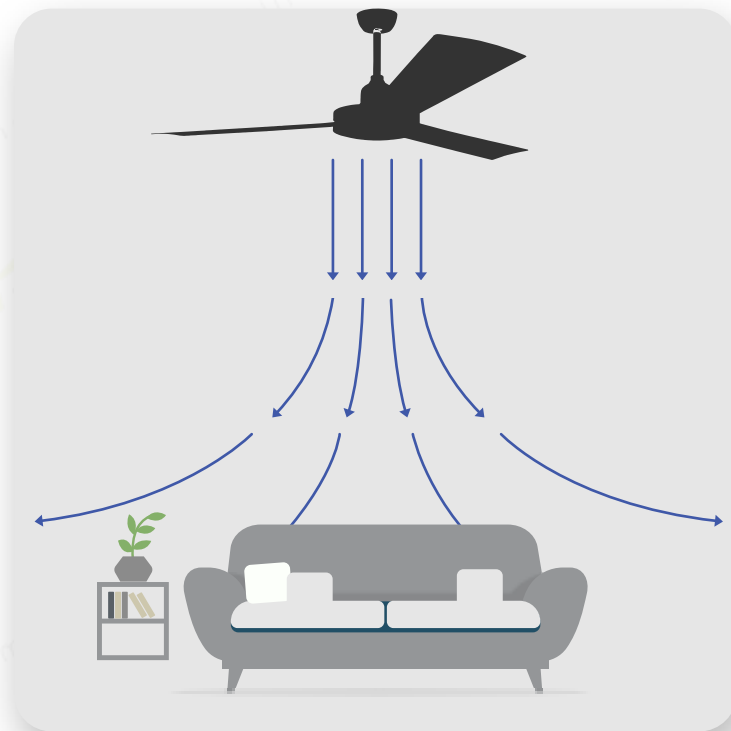

SUMMER OPERATION

clockwise operation pushes air down with a cooling breeze saves cooling cost by supporting air conditioners

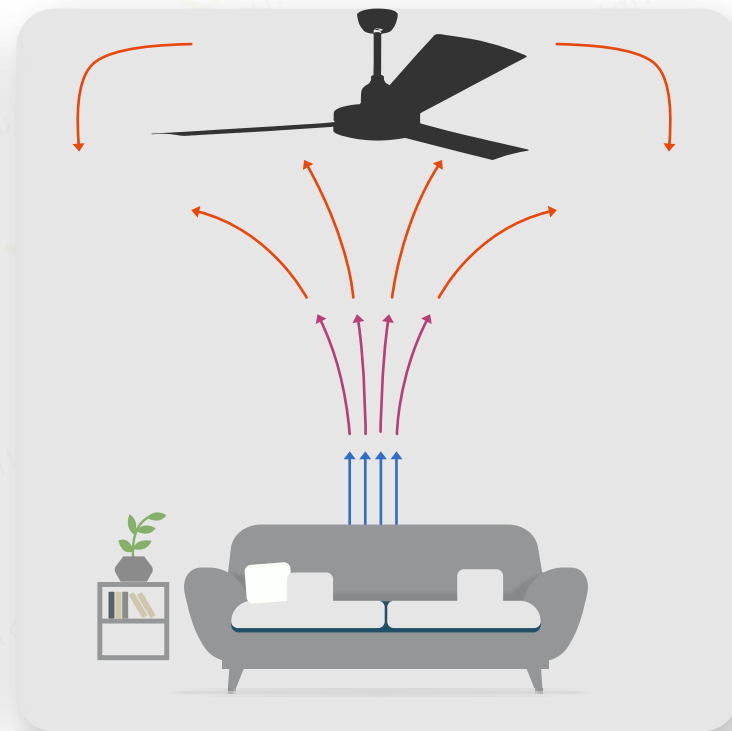

WINTER OPERATION

anti-clockwise operation recirculates warm air trapped on the ceiling down through the walls without creating a breeze. Saves heating cost by eliminating hot air stratification.

ACCESSORIES

- 4 Fan speeds
- Light ON/OFF function (for Fan with Light kits)
- Operate multiple fans with One remote
- Radio control - no need to point at sensor



FAN REMOTE CONTROL

- Solid State Choke type controller
- Extreme Long Life
- Heavy Duty
- No Electronic Parts
- Suits all Models



5 SPEED WALL CONTROLLER

- Save Electricity in Winters
- Pushes trapped HOT Air Down from the ceiling
- Switch to be Manually operated

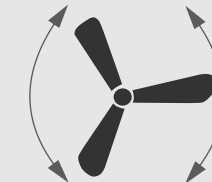

REVERSE OPERATION

- Down-rods of ANY Length up to 6 feet in Single Length
- Down-rods with Joints in ANY LENGTH

CUSTOM LENGTH RODS

- 16 Watt High Power
- Long Life DIMMABLE driver
- SMD Led with long Life
- Supplied with 3 Speed remote controller (to operate fan and light separately)

LED LIGHT KIT

- Special Mount for raked / slant ceilings
- Can mount upto 25 Degree slope
- Remote Control Ready
- Ceiling must take load of 50 Kgs. min.

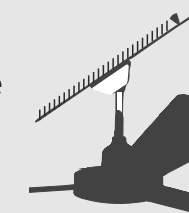

SLOPE ROOF MOUNT

HUGGER FANS

WHEN TO USE



LOW CEILING HEIGHT SPACES

Spaces where available height is less than 2.5 meters (8 feet) is ideal for Hugger fans. For rooms with ceiling height more than 3 meter (9 feet) Rod type fan is recommended for better performance

STANDARD MOUNTING

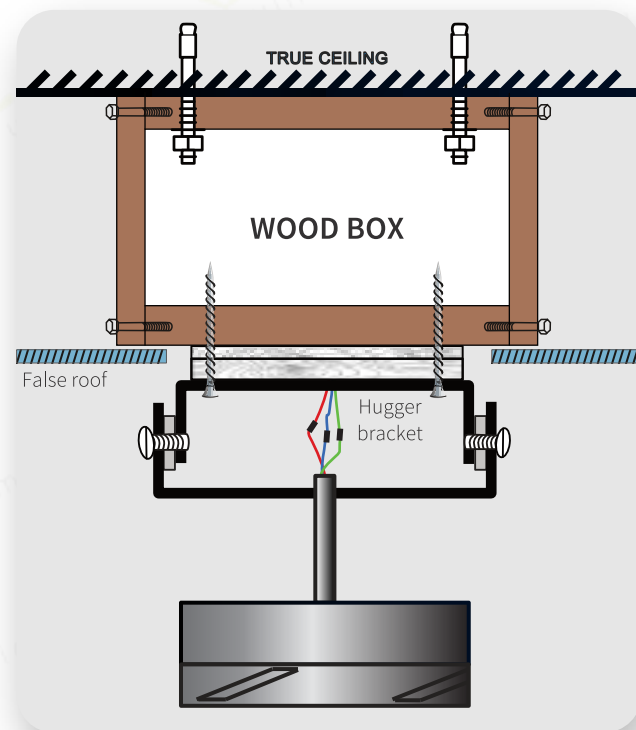

FAN BOX MOUNTING

Wood box is provisioned inside the false roof which bears the load of Hugger fan. This must be done during the false roof installation. *Hugger can also be installed directly on True Ceiling when false roof is not present.*

OPTIONAL MOUNTING

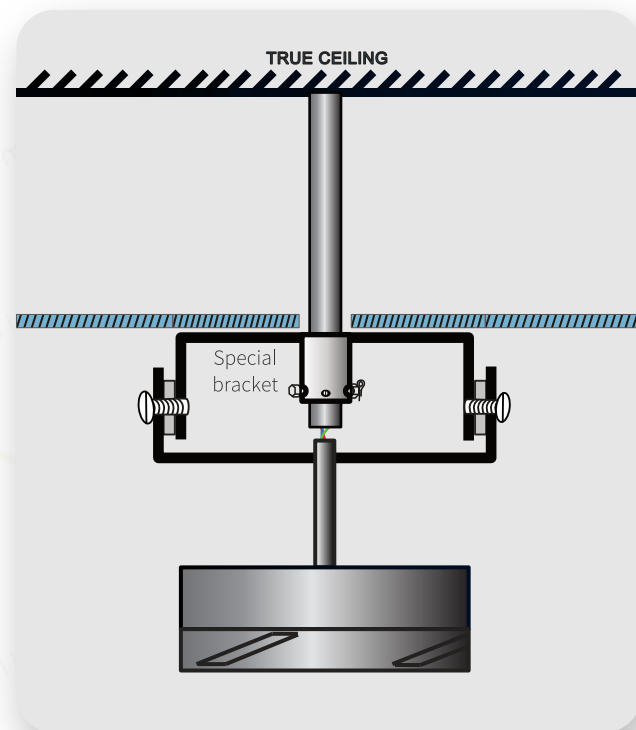

FAN ROD MOUNTING

When a market fan rod is present, Hugger fans can be installed with a Special Bracket. This method requires more effort to install. Fan performance or aesthetics are not affected.

(chargeable extra)

HOME AUTOMATION

When it comes to automation-compatible ceiling fans, there are few important considerations to keep in mind. In addition to the motor type and control options, it's also important to consider the type of speed controller that you'll be using, as well as any compatibility issues that may arise when using automation systems.

- Stepped type speed controllers are preferred
- Triac dimmer speed controllers are not recommended, they can cause a humming sound in the fan.
- If using an automation speed control, it's important to disconnect any remote controls that are currently in use to avoid interference between the two systems.
- Similarly, if using a remote control for the ceiling fan, it's important to disconnect any other speed controllers that are currently in use.
- Not all automation systems provide the same number of speed settings, so it's important to choose a system that offers the level of control desired.

USE CASE 1

Home automation with fan speed controller

- Choose Windmill fans AC Motor without Remote controller
- Fans connected to Automation fan speed controller will control the fan speeds as per the system capability.
- NOTE: All Automation system speed control settings are programmed differently, fans may run higher or slower depending on the speed settings. Windmill fans cannot do anything to control this.
- Reverse operation if opted must be switched manually. It cannot be automation controlled.

USE CASE 2

Home automation with Fan ON/OFF (No Automation speed controller)

- Select any Windmill Fan model WITH Remote speed control
- Fan ON/OFF will work with Automation system and speed can be controlled with remote.
- Windmill Fan remotes have LAST OPERATION MEMORY , so when automation turns on the fan, it will automatically run at last set speed.
- Reverse operation if opted must be switched manually. It cannot be automation controlled.

USE CASE 3

Home automation with IR (Infra-red) or RF (Radio Freq.) Blaster

- Select any Windmill Fan model WITH Remote speed control. Please ensure RF or IR is mentioned in the Order sheet. Fans will be installed with the same receiver.
- IR or RF blaster can be trained/learn the operating frequencies of Windmill remote.
- Once trained/learn , hand remotes to be kept aside and fans will operate on Automation system as per the system capability.
- Reverse operation if opted must be switched manually. It cannot be automation controlled.

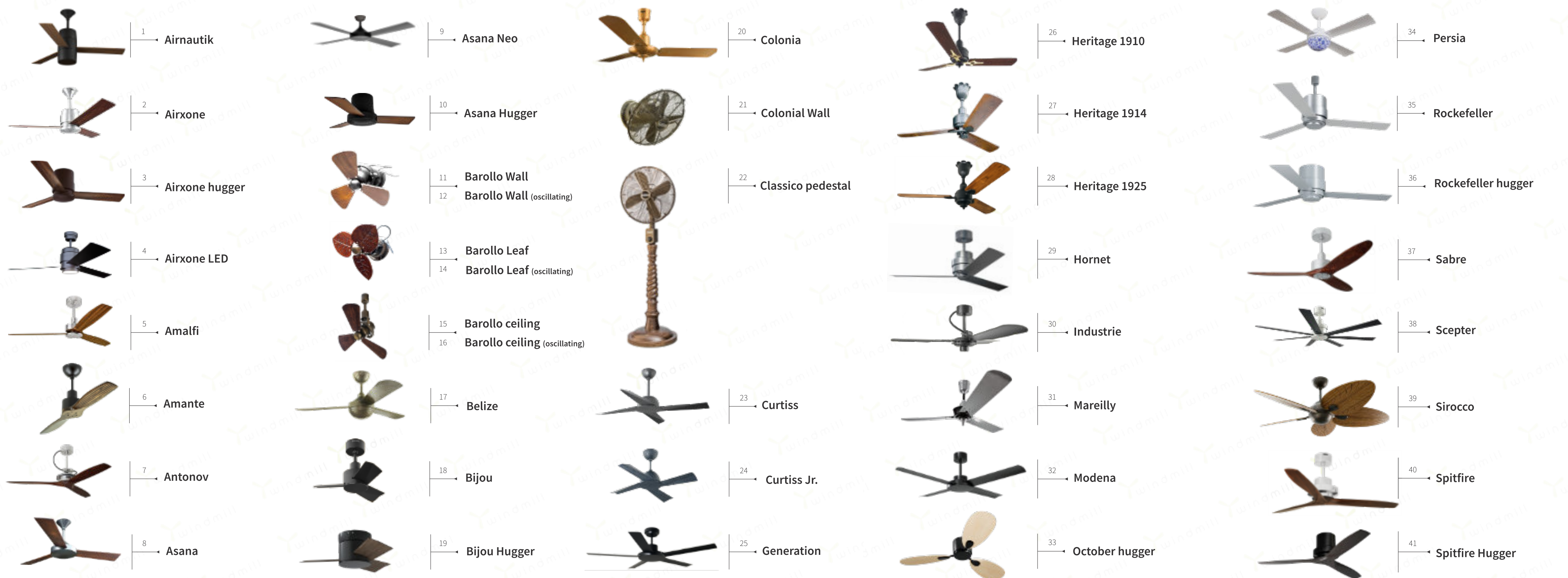

INDEX



42 Stark



47 Tripod



43 Stealth



48 Triton



44 Stealth Hugger



45 Velocita hugger



45 Riviera (Indoor)



50 - 54 Gallery



46 Riviera Mark 2 (Outdoor)



55 - 56 Custom Fan Finishes

CEILING HEIGHT

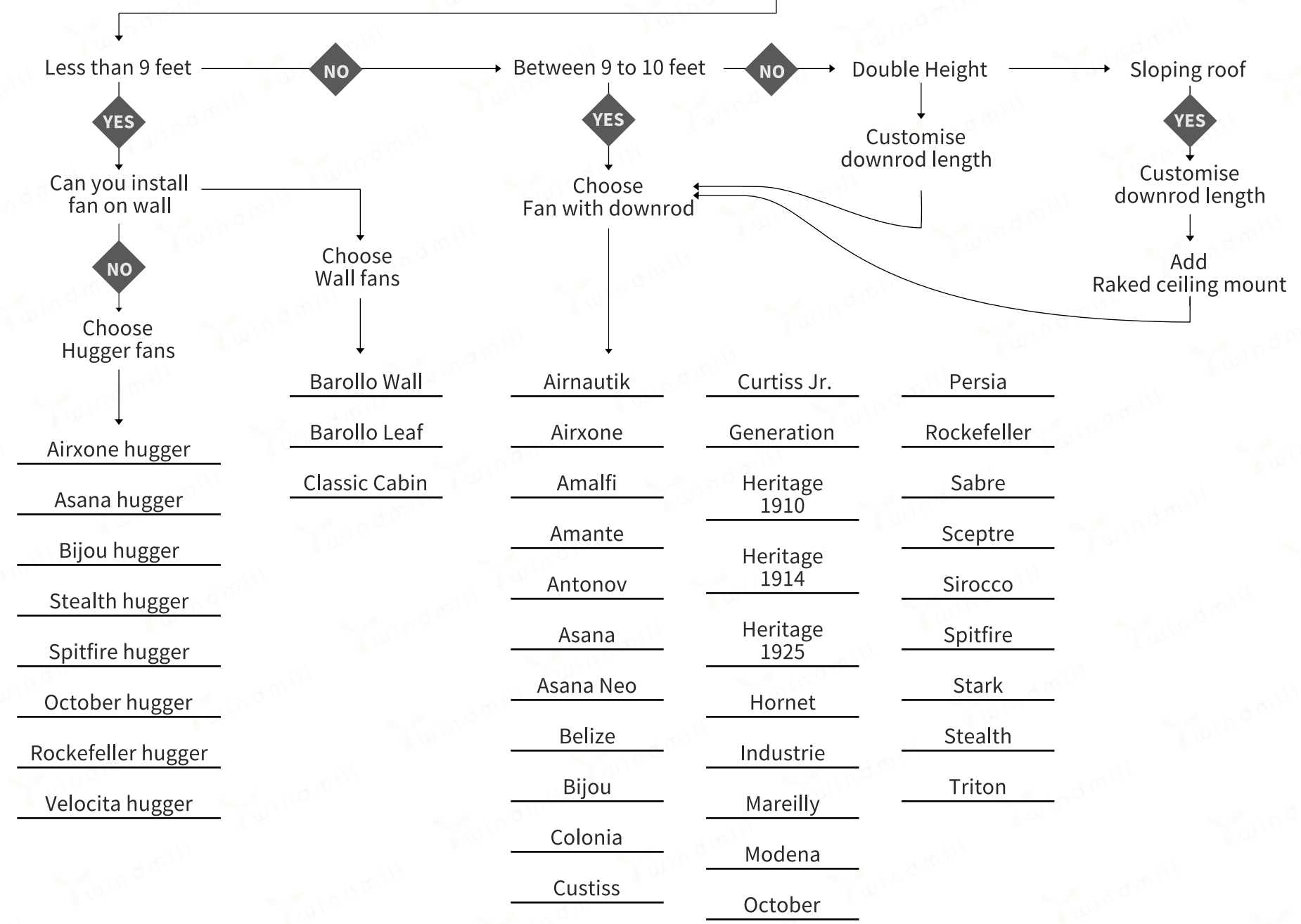

INDEX

900 mm. 1050 mm. 1200 mm. 1300 mm.

Tech specs	Power: 40 watt	45 watt	50 watt	55 watt
	Airflow: 2500 CFM	4500 CFM	5900 CFM	6500 CFM

Standard features

- AC Motor
- Fully compatible with Automation systems

Working environment

- Suitable for indoor use and covered open spaces
- Suitable for covered outdoor use (select finishes)

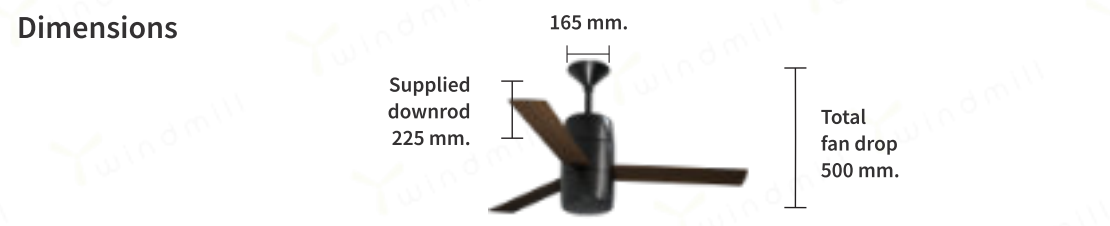
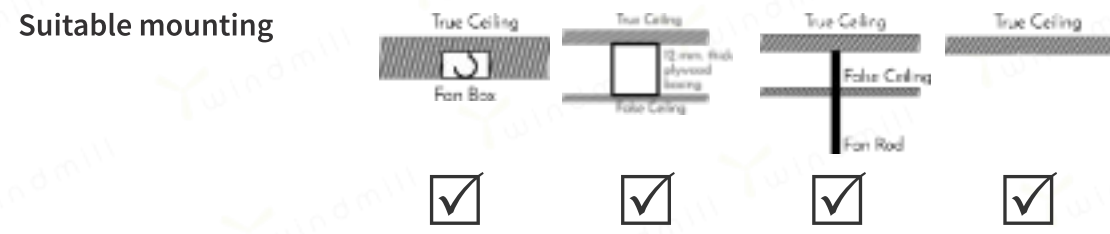

Customisable Sweep sizes (cm.)

- 90
- 105
- 120
- 130

Optional accessories

- 4 speed remote
- 5 speed wall controller
- slant ceiling mount

Customisable finish for fan motor and metal blades

glossy copper	gold	matt copper	antique bronze	matt pewter	oil rubbed bronze
matt black	matt white (RAL 9010)	bright white (RAL 9003)	brushed aluminum	brushed brass	

Customisable material and finish for fan blades

solid teak wood (matt walnut)	solid teak wood (natural matt)	laminated teak wood (walnut matt)	laminated teak wood (natural matt)	beech wood (natural matt)	wood finish metal



900 mm. 1050 mm. 1200 mm. 1300 mm.

Tech specs	Power: 40 watt	45 watt	50 watt	55 watt
	Airflow: 2500 CFM	4500 CFM	5900 CFM	6500 CFM

Standard features	AC Motor
	Fully compatible with Automation systems

Working environment	Suitable for indoor use and covered open spaces
	Suitable for covered outdoor use (select finishes)

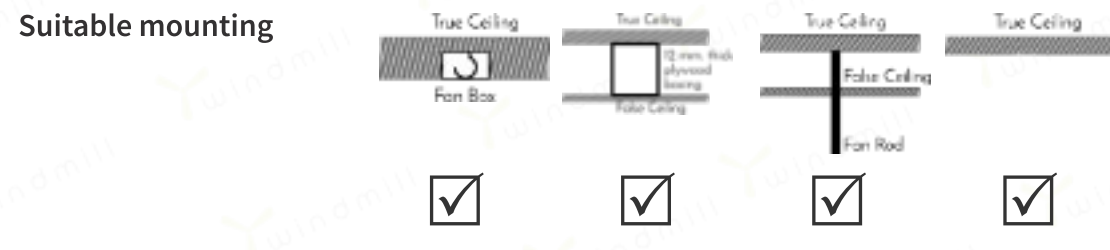

Customisable Sweep sizes (cm.)

- 90
- 105
- 120
- 130

Optional accessories

	4 speed remote		led light kit with remote
	5 speed wall controller		slant ceiling mount

Customisable finish for fan motor and metal blades

glossy copper	gold	matt copper	antique bronze	matt pewter	oil rubbed bronze
matt black	matt white (RAL 9010)	bright white (RAL 9003)	brushed aluminum	brushed brass	

Customisable material and finish for fan blades

solid teak wood (matt walnut)	solid teak wood (natural matt)	lamine teak wood (walnut matt)	lamine teak wood (natural matt)	beech wood (natural matt)	wood finish metal

Matt white	36 INCH 900 MM	42 INCH 1050 MM	48 INCH 1200 MM	Standard finish
Matt black	36 INCH 900 MM	42 INCH 1050 MM	48 INCH 1200 MM	Standard finish
Matt pewter Teak laminate wood (Walnut Matt)	36 INCH 900 MM	42 INCH 1050 MM	48 INCH 1200 MM	Standard finish
Oil rubbed bronze Teak laminate wood (Walnut Matt)	36 INCH 900 MM	42 INCH 1050 MM	48 INCH 1200 MM	Standard finish

Airxone

Sophisticated and modern design, clean Screw-less look with three Blades.

Rugged Die-Cast Aluminium construction, Powered by a 16 Pole.

Super cool reversible motor, designed to perform for a lifetime.

	900 mm.	1050 mm.	1200 mm.	1300 mm.
Tech specs	Power: 40 watt	45 watt	50 watt	55 watt
	Airflow: 2500 CFM	4500 CFM	5900 CFM	6500 CFM

Standard features AC Motor
Fully compatible with Automation systems

Working environment Suitable for indoor use and covered open spaces
Suitable for covered outdoor use (select finishes)

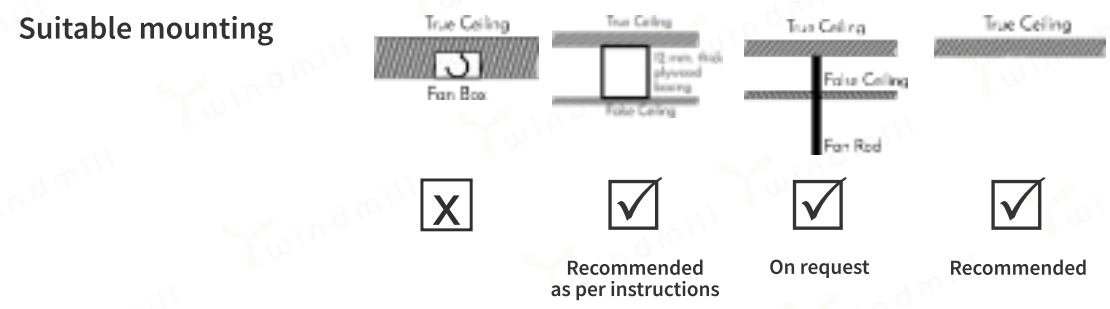

Customisable Sweep sizes (cm.)

60	130
90	
105	
120	

Optional accessories

4 speed remote	led light kit with remote
5 speed wall controller	

Customisable finish for fan motor and metal blades

glossy copper	gold	matt copper	antique bronze	matt pewter	oil rubbed bronze
matt black	matt white (RAL 9010)	bright white (RAL 9003)	brushed aluminum	brushed brass	polished aluminium

Customisable material and finish for fan blades

solid teak wood (matt walnut)	solid teak wood (natural matt)	lamine teak wood (walnut matt)	lamine teak wood (natural matt)	beech wood (natural matt)	wood finish metal
-------------------------------	--------------------------------	--------------------------------	---------------------------------	---------------------------	-------------------

	Matt pewter Teak laminate wood blades (Walnut Matt)	36 INCH 900 MM	42 INCH 1050 MM	48 INCH 1200 MM	Standard finish
	Matt White	36 INCH 900 MM	42 INCH 1050 MM	48 INCH 1200 MM	Standard finish
	Matt black	36 INCH 900 MM	42 INCH 1050 MM	48 INCH 1200 MM	Standard finish
	Oil rubbed bronze Teak laminate wood blades (Walnut Matt)	36 INCH 900 MM	42 INCH 1050 MM	48 INCH 1200 MM	Standard finish

Airxone hugger

Sophisticated and modern design, clean Screw-less look with three Blades.

Rugged Die-Cast Aluminium construction, Powered by a 16 Pole Super cool reversible motor, designed to perform for a lifetime.

HUGGER (Flush Ceiling Mounting) designed to install ceiling fan for Low Height ceilings, without compromise on air delivery



Airxone
led

Standard features

18 Watt LED

Remote control with multiple fan speed and Light ON/OFF

NOTE: Airxone LED is a different model. Airxone cannot be converted/retro-fitted with LED.

All technical, mounting, finish specifications remain same as Airxone.

Dimensions



Airxone
hugger
led

Standard features

18 Watt LED

Remote control with multiple fan speed and Light ON/OFF

NOTE: Airxone Hugger LED is a different model. Airxone Hugger cannot be converted/retro-fitted with LED.

All technical, mounting, finish specifications remain same as Airxone Hugger

Dimensions

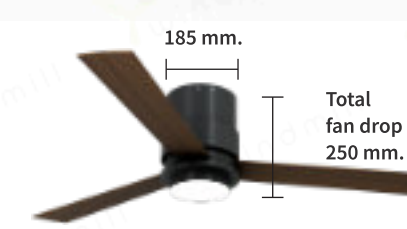

900 mm. 1050 mm. 1200 mm. 1300 mm.

Tech specs	Power:	40 watt	45 watt	50 watt	55 watt
	Airflow:	2500 CFM	4500 CFM	5900 CFM	6500 CFM

Standard features
AC Motor
Fully compatible with Automation systems

Working environment
Suitable for indoor use and covered open spaces
Suitable for covered outdoor use (select finishes)

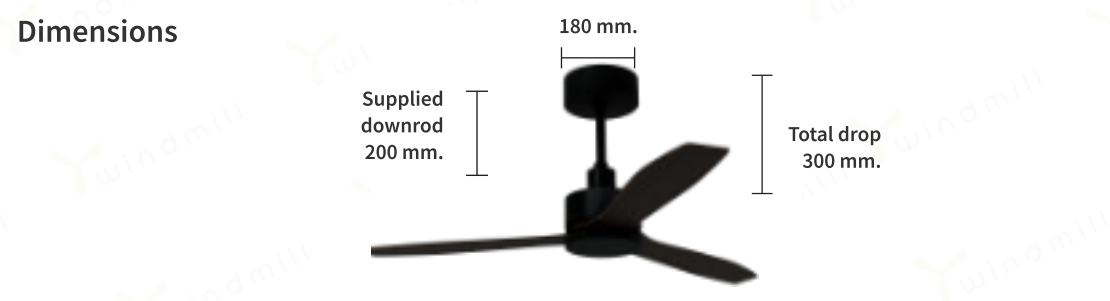
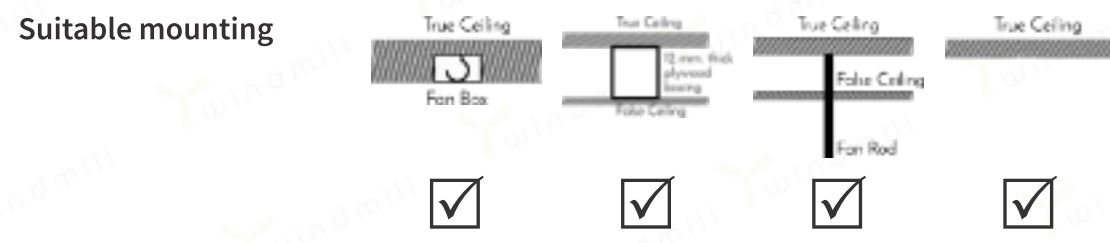

Customisable Sweep sizes (cm.)

- 90
- 105
- 120
- 130

Optional accessories

- 4 speed remote
- reverse operation
- 5 speed wall controller
- slant ceiling mount

Customisable finish for fan motor and metal blades

glossy copper	gold	matt copper	antique bronze	matt pewter	oil rubbed bronze
matt black	matt white (RAL 9010)	bright white (RAL 9003)	brushed aluminum	brushed brass	

Customisable material and finish for fan blades

solid teak wood (matt walnut)	solid teak wood (natural matt)	laminated teak wood (walnut matt)	laminated teak wood (natural matt)	beech wood (natural matt)	wood finish metal

Amalfi

Like the pristine and surreal beaches of Italy, a fan design inspired from the word pure. Simplicity and elegance in its purest form; this design can compliment any style of decoration.

Modern, Contemporary and Classic all work well with Amalfi.

1050 mm. 1180 mm.

Tech specs	Power :	45 watt	50 watt
	Airflow :	5000 CFM	6300 CFM

Standard features AC Motor
Fully compatible with Automation systems

Working environment Suitable for indoor use and covered open spaces
Suitable for covered outdoor use

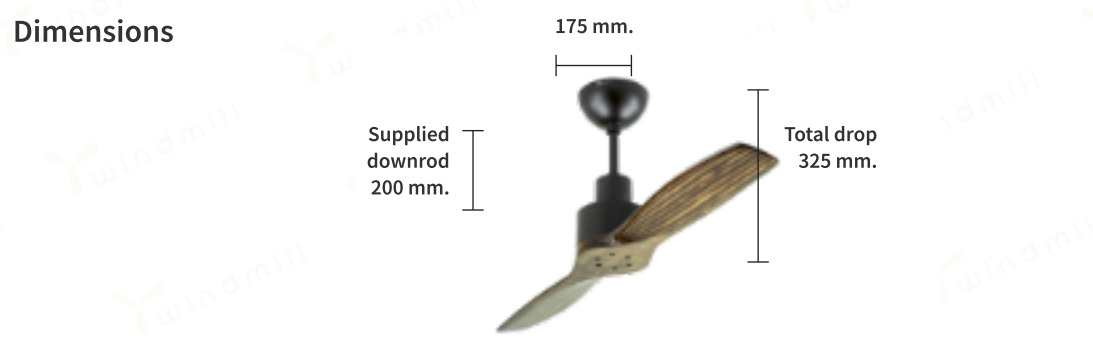
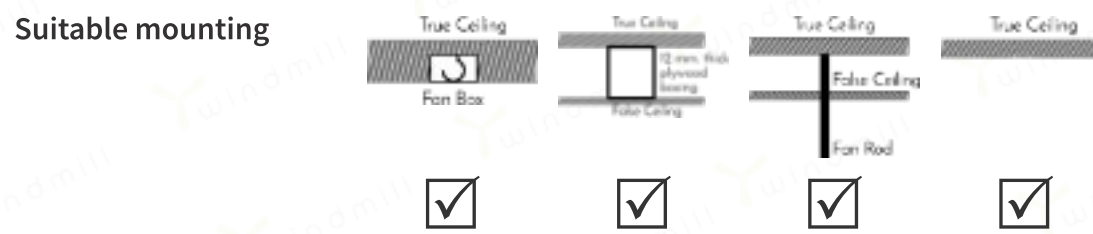

Customisable Sweep sizes (cm.)

90
105
118

Optional accessories

4 speed remote	slant ceiling mount
reverse operation	
5 speed wall controller	

Customisable finish for fan motor and metal blades

matt copper	antique bronze	matt pewter	oil rubbed bronze
matt black	matt white (RAL 9010)	bright white (RAL 9003)	

Customisable material and finish for fan blades

birch wood (walnut matt)	matt black



Matt Black
Birchwood prop.
(Walnut Gloss)

47
INCH
1180 MM

Standard finish



Oil Rubbed Bronze
Birchwood prop.
(Walnut Gloss)

47
INCH
1180 MM

Standard finish



Amante

Elegance and attitude. Twin propeller crafted from the single block of Birchwood.

Smooth natural feel airflow due to natural cutting of air and twin blades. Near silent operation on high speeds makes this fan ideal for corner offices, bedrooms and work from home spaces.

Handcrafted and hand-polished in premium walnut glossy finish

1300 mm. 1400 mm. 1800 mm.

Tech specs	Power:	67 watt	75 watt	140 watt
	Airflow:	8600 CFM	9500 CFM	10000 CFM

Standard features

- AC Motor
- Fully compatible with Automation systems

Working environment

- Suitable for indoor use and covered open spaces
- Not suitable for outdoor spaces with high moisture

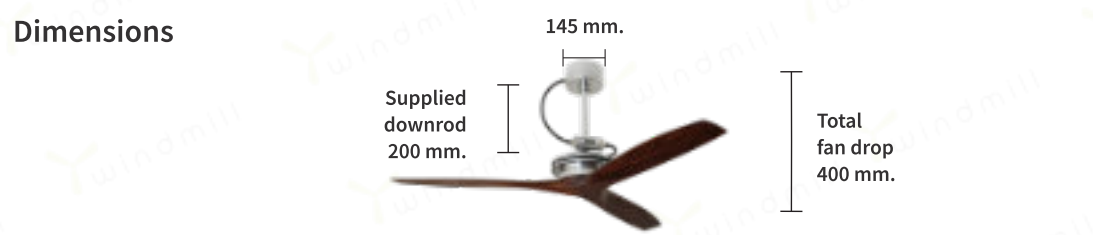
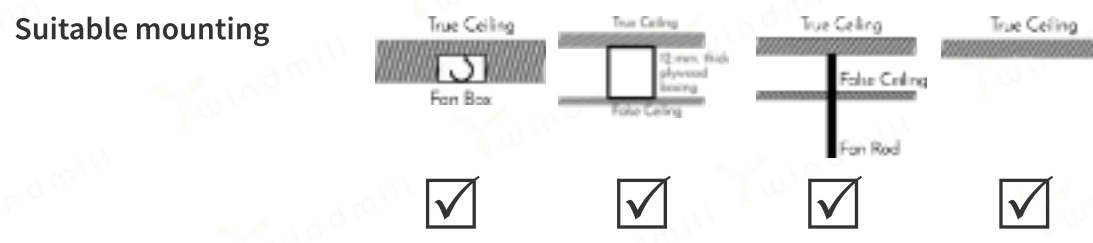

Customisable Sweep sizes (cm.)

105	180
120	
130	
140	

Optional accessories

- 4 speed remote
- 5 speed wall controller
- slant ceiling mount

Customisable finish for fan motor and metal blades

glossy copper	gold	matt copper	antique bronze	matt pewter	oil rubbed bronze
matt black	matt white (RAL 9010)	bright white (RAL 9003)	brushed aluminum	brushed brass	polished aluminium

Customisable material and finish for fan blades

birch wood (walnut matt)	matt black	beech wood (natural matt)



Polished Aluminium
Birchwood propellers
(Dark Walnut matt)

52
INCH
1300 MM

Custom finish



Polished Aluminium
Birchwood propellers
(Matt Black)

52
INCH
1300 MM

Custom finish



Antonov

Made out of Air plane propellers, new motor design with enough air to lift your spirits.

Design so unique it will be noticed. All of this without making a sound.

ANTONOV - Aptly named after an Aviation Legend.

900 mm. 1200 mm. 1400 mm. 1500 mm.

Tech specs	Power :	60 watt	75 watt	75 watt	85 watt
	Airflow :	4500 CFM	6800 CFM	8000 CFM	8500 CFM

Standard features	AC Motor
	Fully compatible with Automation systems

Working environment	Suitable for indoor use and covered open spaces
	Suitable for covered outdoor use (select finishes)

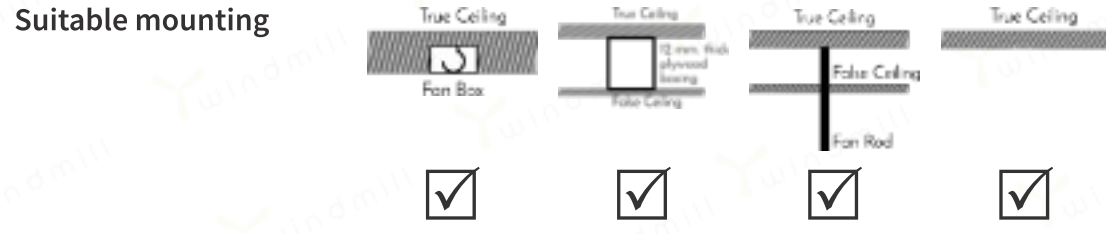

Customisable Sweep sizes (cm.)

90	140
105	150
120	
130	

Optional accessories

- 4 speed remote
- reverse operation
- 5 speed wall controller
- led light kit with remote
- slant ceiling mount

Customisable finish for fan motor and metal blades

glossy copper	gold	matt copper	antique bronze	matt pewter	oil rubbed bronze
matt black	matt white (RAL 9010)	bright white (RAL 9003)	brushed aluminum	brushed brass	polished aluminium

Customisable material and finish for fan blades

solid teak wood (matt walnut)	solid teak wood (natural matt)	laminated teak wood (walnut matt)	laminated teak wood (natural matt)	beech wood (natural matt)	wood finish metal

	<p>Matt white</p> <p>36 INCH 900 MM</p> <p>48 INCH 1200 MM</p> <p>56 INCH 1400 MM</p>	Standard finish
	<p>Matt black</p> <p>36 INCH 900 MM</p> <p>48 INCH 1200 MM</p> <p>56 INCH 1400 MM</p>	Standard finish
	<p>Matt Black Teak laminate wood (Walnut matt)</p> <p>36 INCH 900 MM</p> <p>48 INCH 1200 MM</p> <p>56 INCH 1400 MM</p>	Standard finish
	<p>Matt pewter Teak laminate wood Walnut matt)</p> <p>36 INCH 900 MM</p> <p>48 INCH 1200 MM</p> <p>56 INCH 1400 MM</p>	Standard finish

Asana

" Simple is Sophisticated ", clean Screw-less look with three Blades, with flexibility to add LED light kit.

Solid Teak wood blades to change the look of the fan completely.

Rugged Die-Cast Aluminium construction, Powered by a 18 Pole Super cool reversible motor, designed to perform for a lifetime.

		1200 mm.	1400 mm.	1500 mm.	1600 mm.
Tech specs	Power :	70 watt	80 watt	85 watt	90 watt
	Airflow :	6500 CFM	7500 CFM	8000 CFM	8500 CFM

Standard features	AC Motor
	Fully compatible with Automation systems

Working environment	Suitable for indoor use and covered open spaces
	Suitable for covered outdoor use (select finishes)

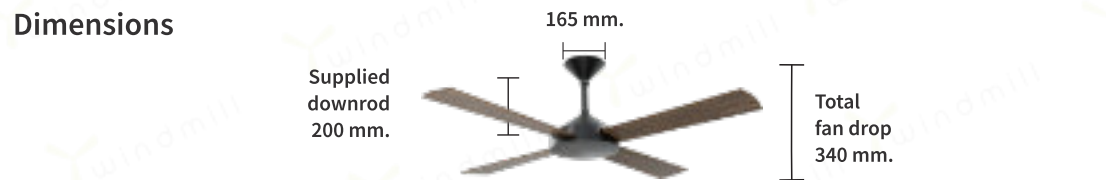
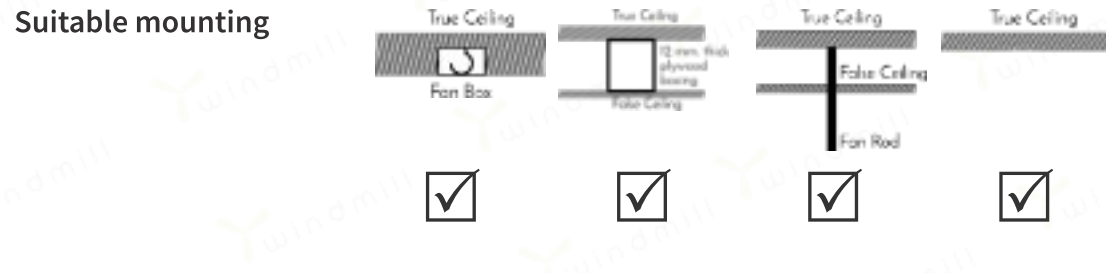

Customisable Sweep sizes (cm.)

105	150
120	160
130	
140	

Optional accessories

	4 speed remote		led light kit with remote
	reverse operation		slant ceiling mount
	5 speed wall controller		

Customisable finish for fan motor and metal blades

glossy copper	gold	matt copper	antique bronze	matt pewter	oil rubbed bronze
matt black	matt white (RAL 9010)	bright white (RAL 9003)	brushed aluminum	brushed brass	polished aluminium

Customisable material and finish for fan blades

wood finish metal

	Matt Pewter	48 INCH 1200 MM	56 INCH 1400 MM	Standard finish
	Matt black	48 INCH 1200 MM	56 INCH 1400 MM	Standard finish
	Matt white	48 INCH 1200 MM	56 INCH 1400 MM	Standard finish
	Matt white wood finish metal blades	48 INCH 1200 MM	56 INCH 1400 MM	Standard finish
	Matt black wood finish metal blades	48 INCH 1200 MM	56 INCH 1400 MM	Standard finish

Asana neo

A fan designed for Large Spaces with minimal design elements, straight lines and organic shapes.

Light blades enable large sweep size" Simple is Sophisticated ", clean Screw-less look. FOUR Blades enhances this models aesthetically pleasing and balanced feel.

Die-Cast Aluminium construction with 18 Pole Super Heavy Duty Motor. Suitable for the most demanding applications.

		900 mm.	1050 mm.	1200 mm.	1300 mm.
Tech specs	Power :	60 watt	60 watt	75 watt	80 watt
	Airflow :	4500 CFM	5500 CFM	6800 CFM	7300 CFM

Standard features AC Motor
Fully compatible with Automation systems

Working environment Suitable for indoor use and covered open spaces
Suitable for covered outdoor use (select finishes)

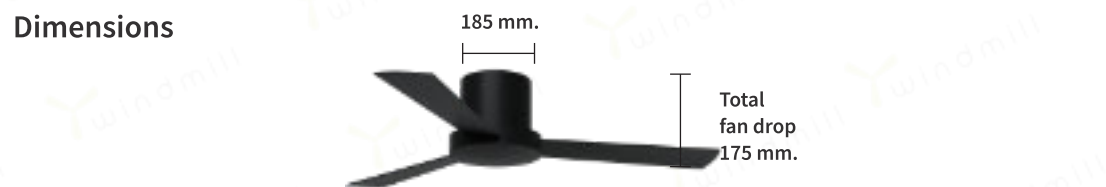
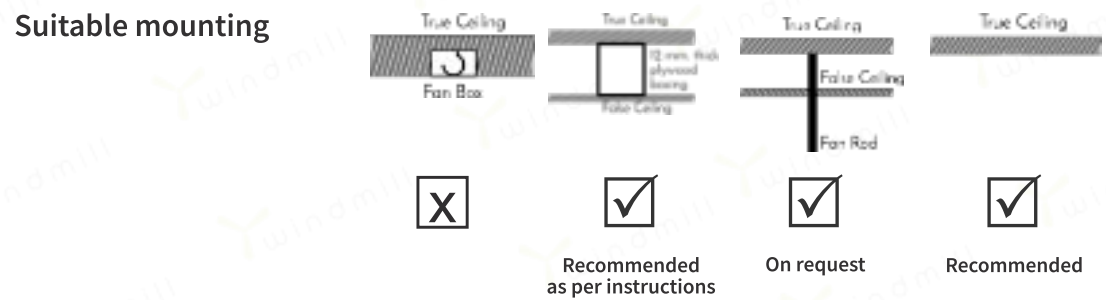

Customisable Sweep sizes (cm.)

- 90
- 105
- 120
- 130

Optional accessories

	4 speed remote		led light kit with remote
	5 speed wall controller		

Customisable finish for fan motor and metal blades

glossy copper	gold	matt copper	antique bronze	matt pewter	oil rubbed bronze
matt black	matt white (RAL 9010)	bright white (RAL 9003)	brushed aluminum	brushed brass	polished aluminium

Customisable material and finish for fan blades

solid teak wood (matt walnut)	solid teak wood (natural matt)	lamine teak wood (walnut matt)	lamine teak wood (natural matt)	beech wood (natural matt)	wood finish metal

	Matt white	Standard finish	
	36 INCH 900 MM	42 INCH 1050 MM	48 INCH 1200 MM
	Matt Black	Standard finish	
	36 INCH 900 MM	42 INCH 1050 MM	48 INCH 1200 MM
	Matt Pewter Teak laminate wood (Walnut matt)	Standard finish	
	36 INCH 900 MM	42 INCH 1050 MM	48 INCH 1200 MM
	Matt Black Teak laminate wood (Walnut matt)	Standard finish	
	36 INCH 900 MM	42 INCH 1050 MM	48 INCH 1200 MM

Asana hugger

HUGGER (Flush Ceiling Mounting) designed to install ceiling fan for Low Height ceilings, without compromise on air delivery

" Simple is Sophisticated ", clean Screw-less look with three Blades.
Solid Teak wood blades to change the look of the fan completely.

		400 mm.	450 mm.	550 mm.
Tech specs	Power :	70 watt	80 watt	85 watt
	Airflow :	3900 CFM	4175 CFM	4500 CFM

Standard features

- AC Motor
- 3 speed controller (pull chain)
- Fully compatible with Automation systems

Working environment

- Suitable for indoor use and covered open spaces
- Suitable for covered outdoor use (select finishes)

Suitable mounting

Wall mounted / Can also be installed on Ceiling (refer to installation guide)

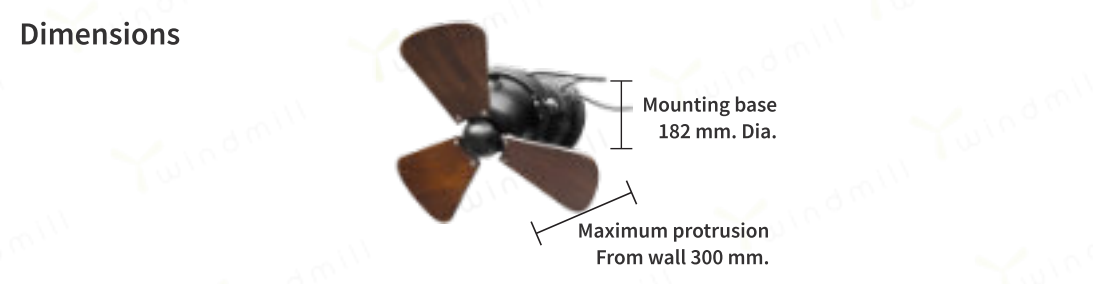

Customisable Sweep sizes (cm.)

40
45
55

Optional accessories

- 4 speed remote
- 5 speed wall controller

Customisable finish for fan motor and metal blades

Customisable material and finish for fan blades

Matt Black
Solid teak wood blades (Walnut Matt finish)

18 INCH 450 MM 22 INCH 550 MM

Antique Bronze
Solid Teak wood blades (Walnut Matt finish)

18 INCH 450 MM 22 INCH 550 MM

Custom finish

Standard finish

Barollo
wall

Like the greatest wine in Italy, comes the most elegant Wall fan.

Solid natural Teak blades, guard-less design, 3 speed inbuilt speed regulator, 360 degree swivel (manual) ensures adaptability to any space.

Designed to inspire.

		400 mm.	450 mm.
Tech specs	Power :	70 watt	80 watt
	Airflow :	3900 CFM	4175 CFM

Standard features

- AC Motor
- 3 speed controller (pull chain)
- Auto-swing on/off (pull chain)
- Fully compatible with Automation systems

Working environment

- Suitable for indoor use and covered open spaces
- Suitable for covered outdoor use (select finishes)

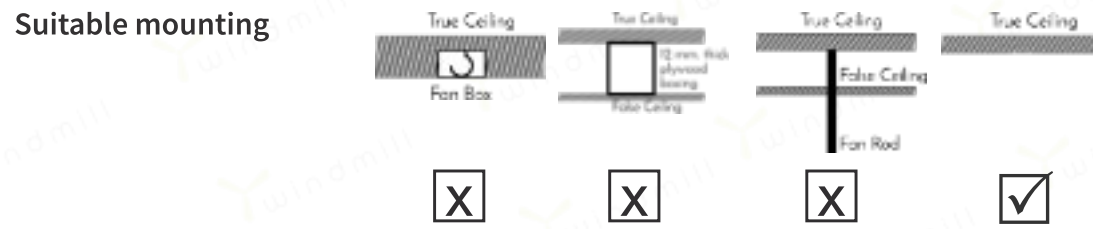

Wall mounted / Can also be installed on Ceiling (refer to installation guide)

Dimensions

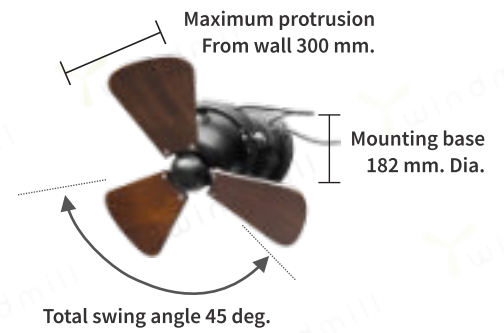

Customisable Sweep sizes (cm.)

40
45

Optional accessories

4 speed remote (Auto swingon/off)

5 speed wall controller

Customisable finish for fan motor and metal blades

Customisable material and finish for fan blades

Matt Black
Solid teak wood blades
(Walnut Matt finish)

16 INCH 400 MM 18 INCH 450 MM

Antique Bronze
Solid Teak wood blades
(Walnut Matt finish)

16 INCH 400 MM 18 INCH 450 MM

Custom finish

Standard finish

Barollo

wall oscillating

Like the greatest wine in Italy, comes the most elegant Wall fan.
Solid natural Teak blades, guard-less design, 3 speed inbuilt speed regulator, auto oscillating mechanism ensures air delivery in a wide area.
Designed to inspire.

	400 mm.	450 mm.
Tech specs	Power : 70 watt	80 watt
	Airflow : 3900 CFM	4175 CFM

Standard features

- AC Motor
- 3 speed controller (pull chain)
- Auto-swing on/off (pull chain)
- Fully compatible with Automation systems

Working environment

- Suitable for indoor use and covered open spaces
- Suitable for covered outdoor use (select finishes)

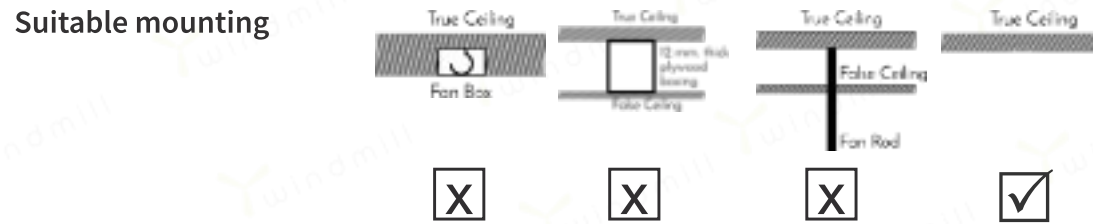

Wall mounted / Can also be installed on Ceiling (refer to installation guide)

Dimensions

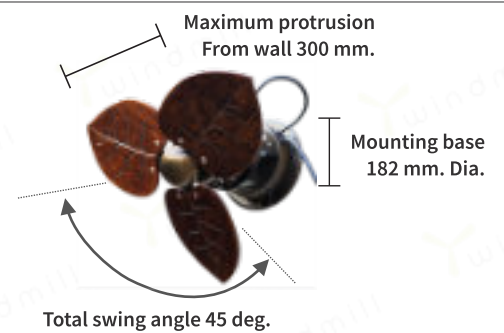

Customisable Sweep sizes (cm.)

40

45

Optional accessories

4 speed remote (Auto swing on/off)

5 speed wall controller

Customisable finish for fan motor and metal blades

Customisable material and finish for fan blades

Antique Bronze
Teak wood blades
(Walnut Matt finish)

16 INCH
400 MM

18 INCH
450 MM

Standard finish

Barollo

leaf oscillating

Reinventing Barollo with tropical leaf blades. Intricately carved veins add great depth and visual appeal to the leaf blade design. Guard-less design, 3 speed inbuilt speed regulator, auto oscillating movement ensure wide air delivery.

Re-Designed to inspire.

450 mm. 550 mm.

Tech specs	Power:	80 watt	85 watt
	Airflow:	3800 CFM	4300 CFM

Standard features

- AC Motor
- 3 speed controller (pull chain)
- Fully compatible with Automation systems

Working environment

- Suitable for indoor use and covered open spaces
- Suitable for covered outdoor use (select finishes)

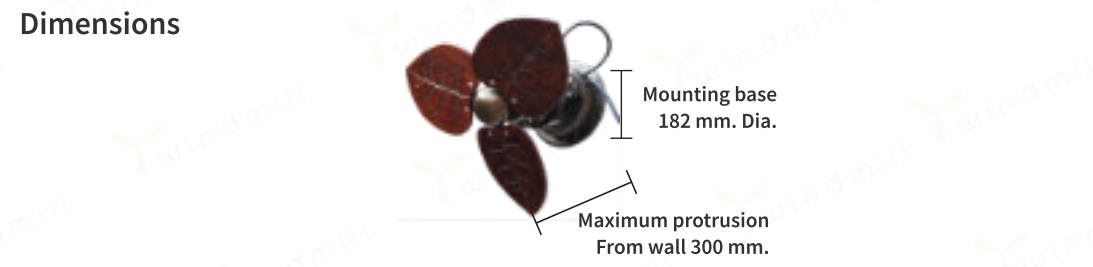
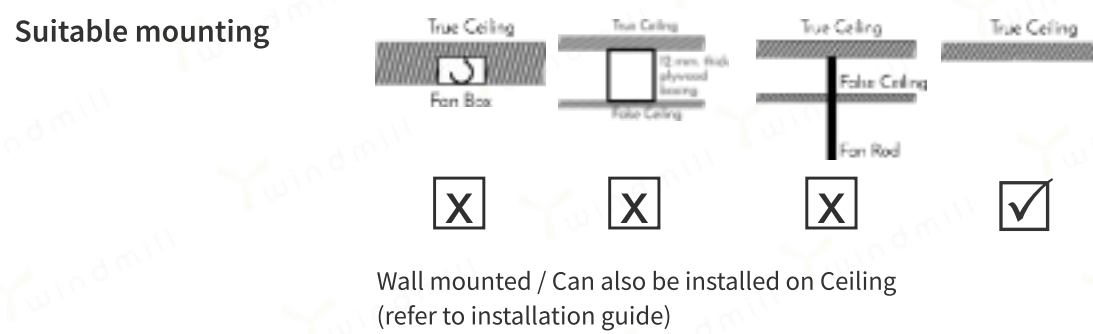

Customisable Sweep sizes (cm.)

40		4 speed remote	
45			5 speed wall controller

Customisable finish for fan motor and metal blades

gold	matt copper	antique bronze	matt pewter	oil rubbed bronze
matt black	matt white (RAL 9010)	bright white (RAL 9003)		

Customisable material and finish for fan blades

laminate teak wood (walnut matt)	laminate teak wood (natural matt)

Optional accessories

Antique Bronze
Teak laminate wood blades
(Walnut Matt finish)

18 INCH 450 MM 22 INCH 550 MM

Standard finish

Barollo leaf

Reinventing Barollo with tropical leaf blades. Intricately carved veins add great depth and visual appeal to the leaf blade design.

Guard-less design, 3 speed inbuilt speed regulator, 360 degree swivel ensures adaptability to any space.

Re-Designed to inspire.

400 mm. 450 mm.

Tech specs	Power :	70 watt	80 watt
	Airflow :	3900 CFM	4175 CFM

Standard features AC Motor
Fully compatible with Automation systems

Working environment Suitable for indoor use and covered open spaces
Suitable for covered outdoor use (select finishes)

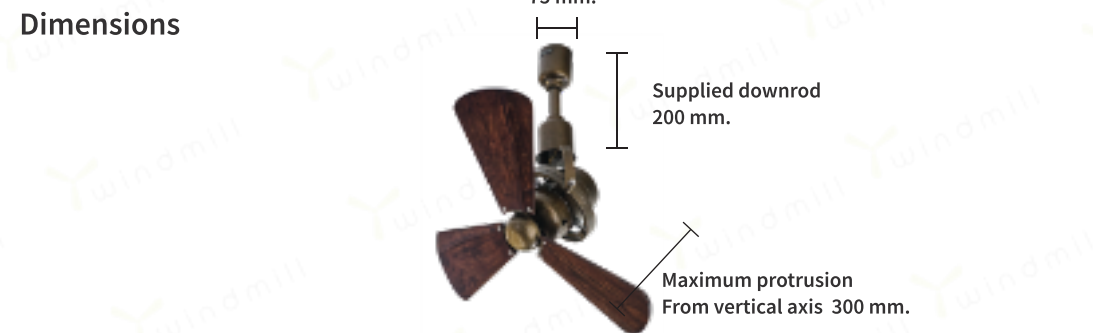
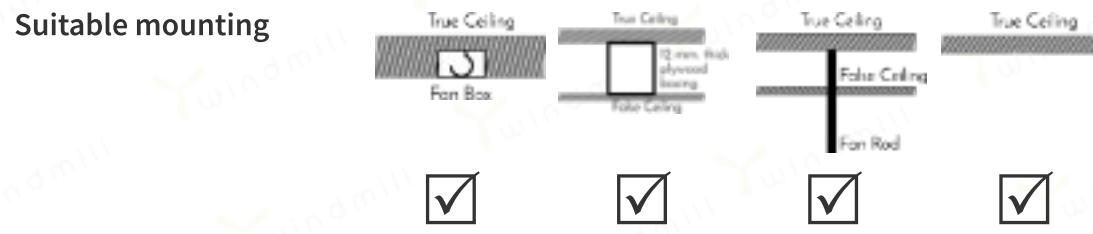

Customisable Sweep sizes (cm.)

40
45
55

Optional accessories

4 speed remote

5 speed wall controller

Customisable finish for fan motor and metal blades

Customisable material and finish for fan blades

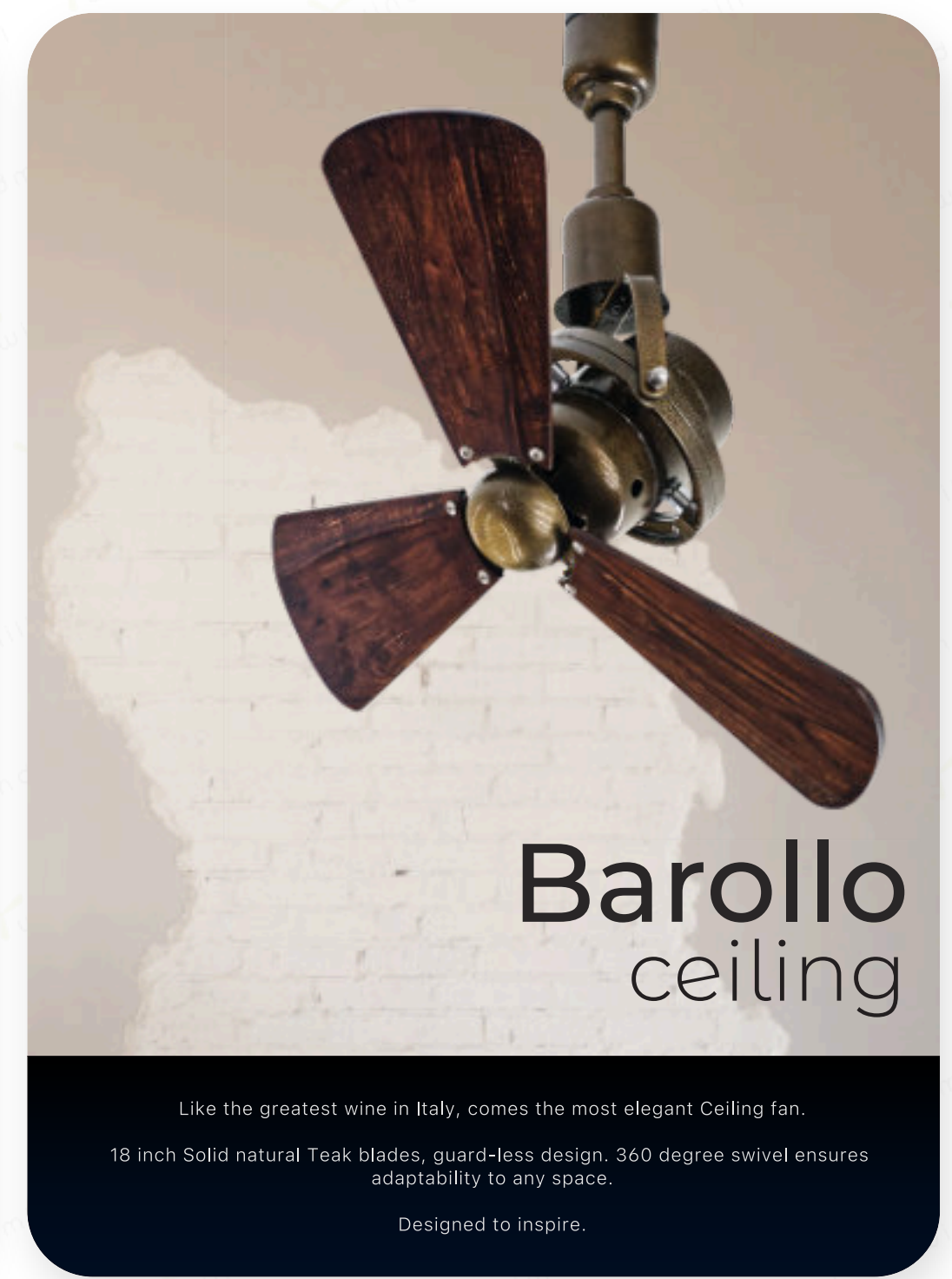
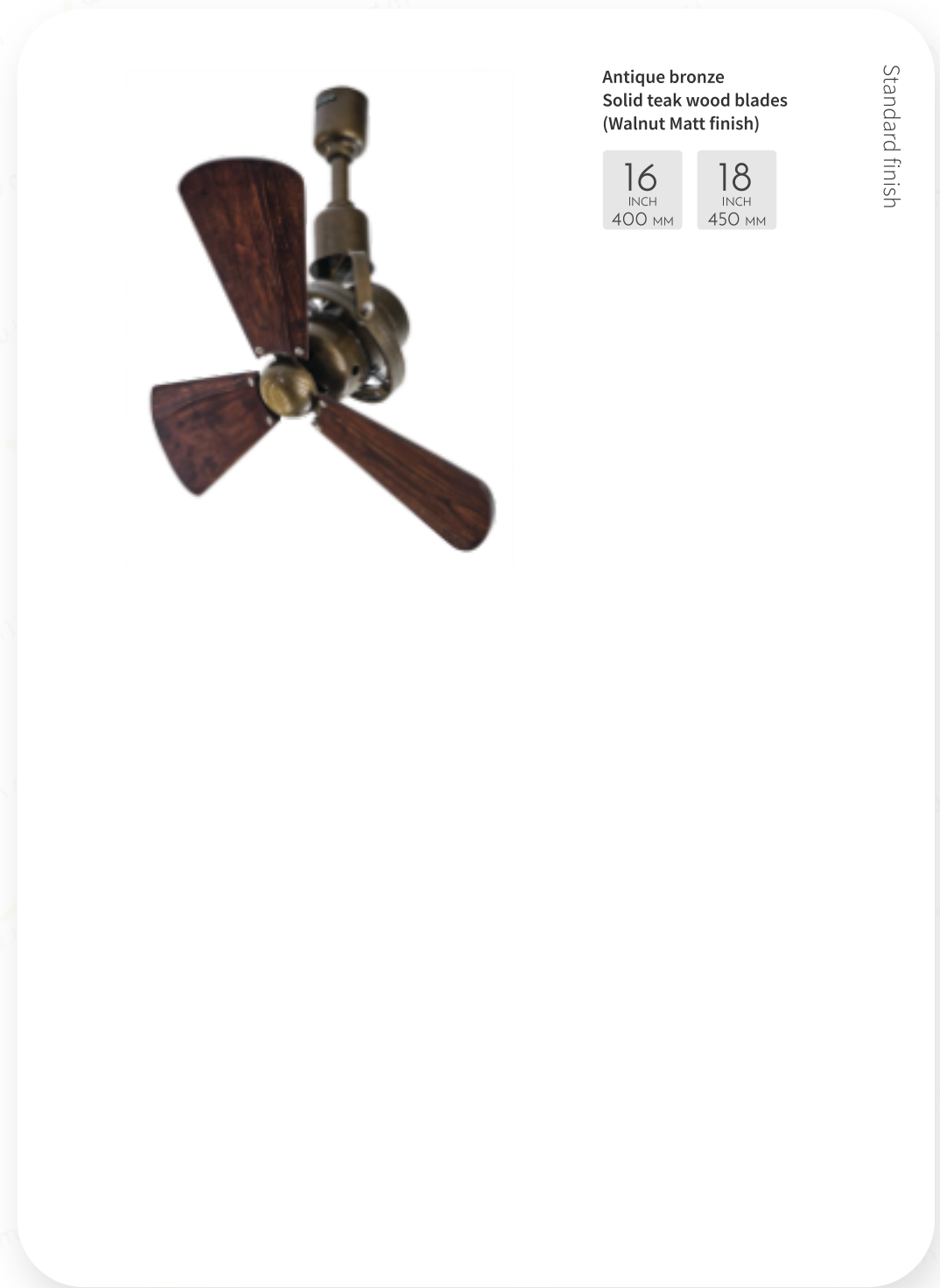

Like the greatest wine in Italy, comes the most elegant Ceiling fan.
18 inch Solid natural Teak blades, guard-less design. 360 degree swivel ensures adaptability to any space.
Designed to inspire.

	400 mm.	450 mm.
Tech specs	Power : 70 watt	80 watt
	Airflow : 3900 CFM	4175 CFM

Standard features

- AC Motor
- Compatible with Automation systems (ON/OFF only)
- 4 speed remote control
- Auto-Swing control via remote

Working environment

- Suitable for indoor use and covered open spaces
- Suitable for covered outdoor use (select finishes)

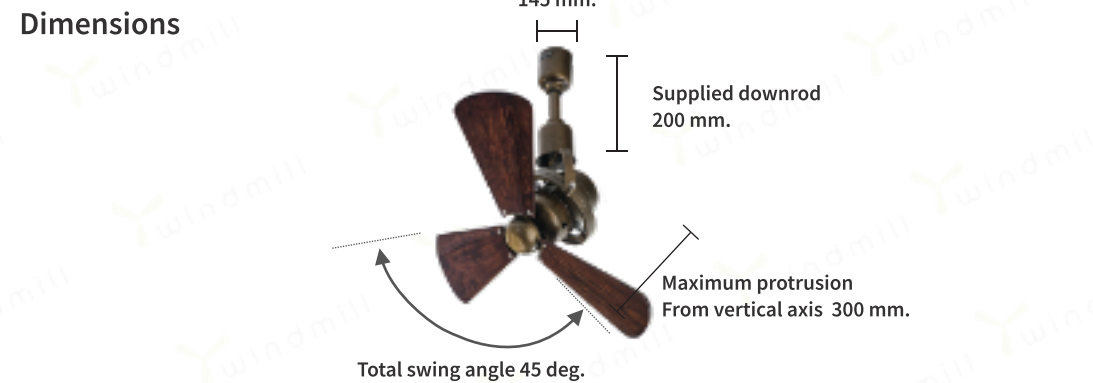
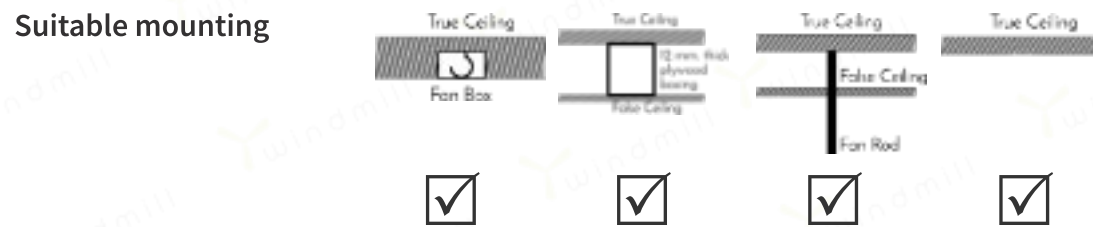

Customisable Sweep sizes (cm.)

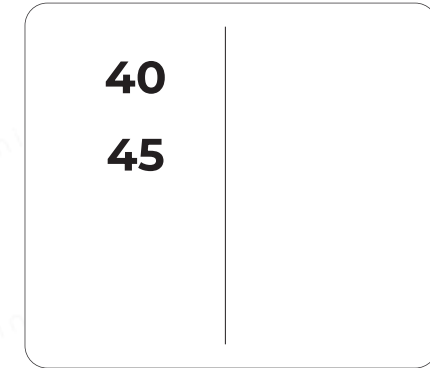

Customisable finish for fan motor and metal blades



Customisable material and finish for fan blades

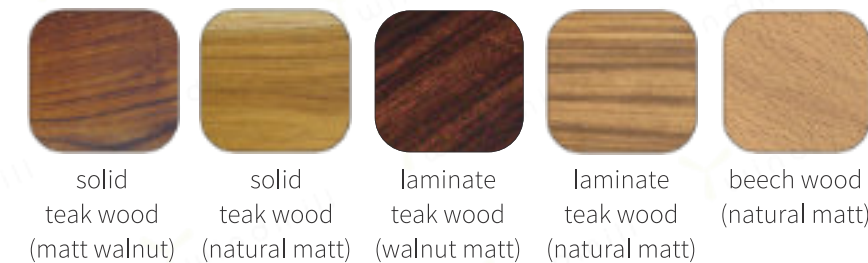

Antique bronze
Solid teak wood blades
(Walnut Matt finish)

16
INCH
400 MM

18
INCH
450 MM

Standard finish



Barollo
ceiling
oscillating

Like the greatest wine in Italy, comes the most elegant Ceiling fan.

18 inch Solid natural Teak blades, guard-less design. Auto oscillating ensures a wide air delivery sweep ensuring air delivery in every corner of your space. Easy to use with remote control speed and oscillating mechanism. Designed to inspire.

900 mm. 1050 mm. 1200 mm. 1300 mm.

Tech specs	Power :	60 watt	60 watt	75 watt	80 watt
	Airflow :	4500 CFM	5500 CFM	6800 CFM	7300 CFM

Standard features AC Motor
Fully compatible with Automation systems

Working environment Suitable for indoor use and covered open spaces
Suitable for covered outdoor use (select finishes)

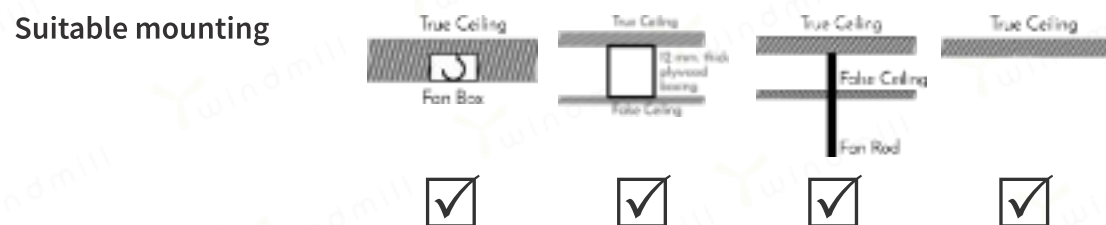

Customisable Sweep sizes (cm.)

90	140
105	150
120	
130	

Optional accessories

	4 speed remote
	5 speed wall controller
	slant ceiling mount

Customisable finish for fan motor and metal blades

gold	matt copper	antique bronze	matt pewter	oil rubbed bronze
matt black	matt white (RAL 9010)	bright white (RAL 9003)		

Customisable material and finish for fan blades

wood finish metal

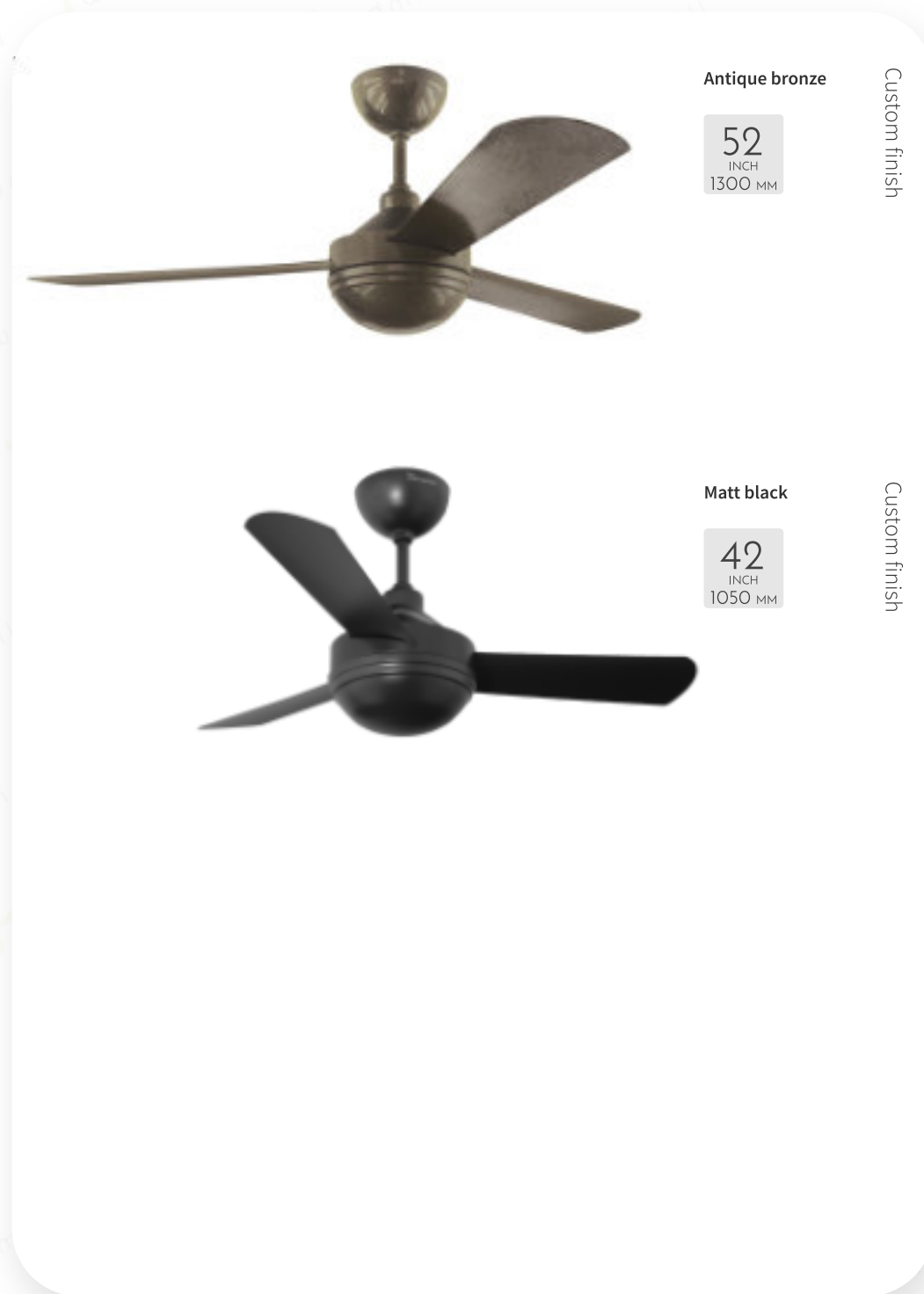

home

An elegant design which is Elegantly classic as well as Tropical.
Large body and smooth edges makes this fan blend with any decorative style.
Large air delivery guaranteed along with subtle style and awe !

600 mm. 900 mm.

Tech specs	Power :	40 watt	45 watt
	Airflow :	1785 CFM	2000 CFM

Standard features AC Motor
Fully compatible with Automation systems

Working environment Suitable for indoor use and covered open spaces
Suitable for covered outdoor use (select finishes)
Suitable for Bathrooms and damp spaces

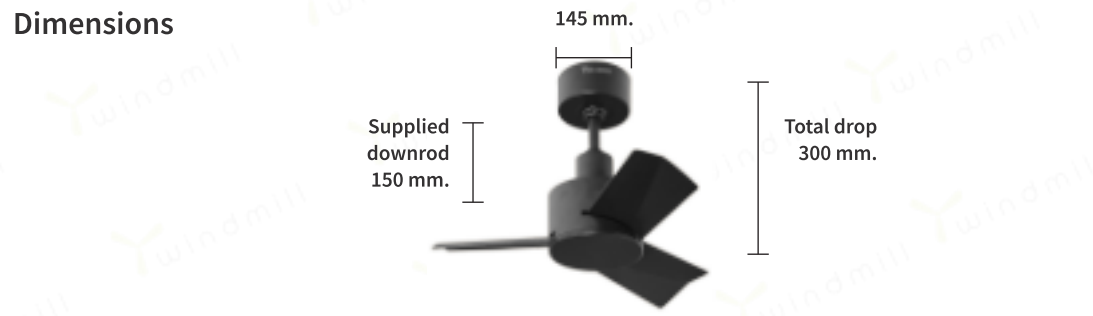
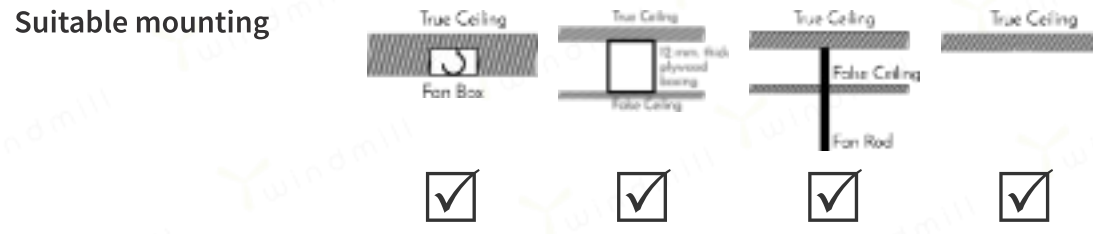

Customisable Sweep sizes (cm.)

60
90

Optional accessories

- 4 speed remote
- 5 speed wall controller
- slant ceiling mount

Customisable finish for fan motor and metal blades

- glossy copper
- gold
- matt copper
- antique bronze
- matt pewter
- oil rubbed bronze
- matt black
- matt white (RAL 9010)
- bright white (RAL 9003)
- brushed aluminum
- brushed brass

Customisable material and finish for fan blades

- solid teak wood (matt walnut)
- solid teak wood (natural matt)
- lamine teak wood (walnut matt)
- lamine teak wood (natural matt)
- beech wood (natural matt)
- wood finish metal

Matt Black

24 INCH 600 MM | 36 INCH 900 MM

Matt White

24 INCH 600 MM | 36 INCH 900 MM

Standard finish

Bijou

Simplicity and elegance in a small package.

Bijou "small" is specially designed for small spaces. Moisture sealed motor for damp locations.

Powerhouse motor churns out huge volumes of air with ease. This high speed fan ideal for Wardrobes, Bathrooms, patios and balconies.

600 mm. 900 mm.

Tech specs
 Power: 40 watt 45 watt
 Airflow: 1785 CFM 2000 CFM

Standard features
 AC Motor
 Fully compatible with Automation systems

Working environment
 Suitable for indoor use and covered open spaces
 Suitable for covered outdoor use (select finishes)
 Suitable for Bathrooms and damp spaces

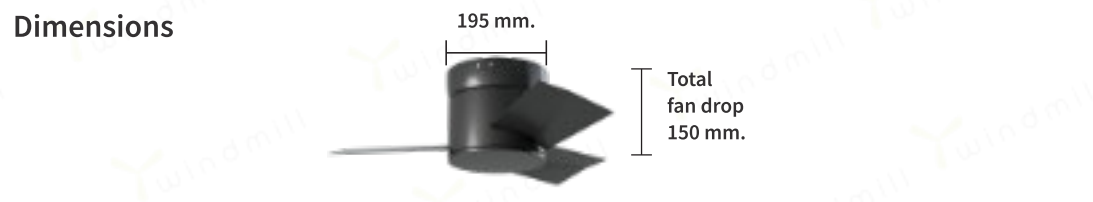
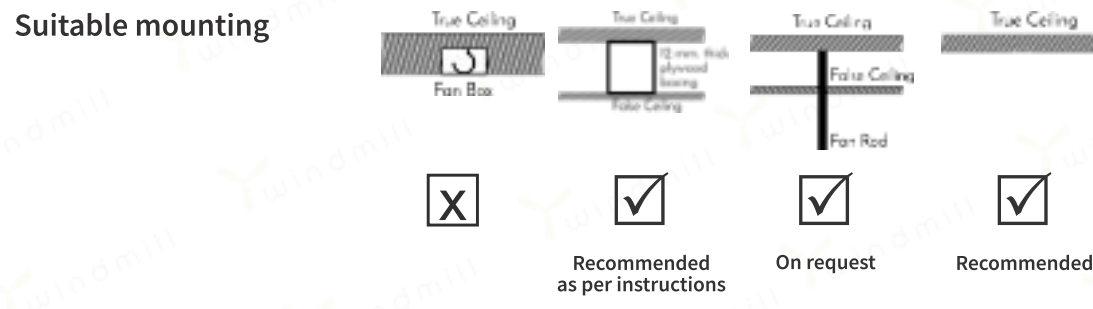

Customisable Sweep sizes (cm.)

60
90

Optional accessories

4 speed remote

5 speed wall controller

Customisable finish for fan motor and metal blades

glossy copper gold matt copper antique bronze matt pewter oil rubbed bronze

matt black matt white (RAL 9010) bright white (RAL 9003) brushed aluminum brushed brass

Customisable material and finish for fan blades

solid teak wood (matt walnut) solid teak wood (natural matt) laminate teak wood (walnut matt) laminate teak wood (natural matt) beech wood (natural matt) wood finish metal

Matt white
24 INCH 600 MM 36 INCH 900 MM

Matt black
24 INCH 600 MM 36 INCH 900 MM

Matt pewter
24 INCH 600 MM 36 INCH 900 MM

Standard finish
Standard finish
Custom finish



Bijou hugger

HUGGER (Flush Ceiling Mounting) designed to install ceiling fan for Low Height ceilings, without compromise on air delivery.

Bijou meaning "Small" now redesigned for bathrooms and closets with Low ceiling spaces.

Powerhouse motor with minimal fan drop makes this a perfect choice for your space.

1200 mm. 1400 mm. 1500 mm.

Tech specs	Power:	65 watt	75 watt	80 watt
	Airflow:	7000 CFM	9500 CFM	10500 CFM

Standard features

- AC Motor
- Fully compatible with Automation systems

Working environment

- Suitable for indoor use and covered open spaces
- Suitable for covered outdoor use (select finishes)

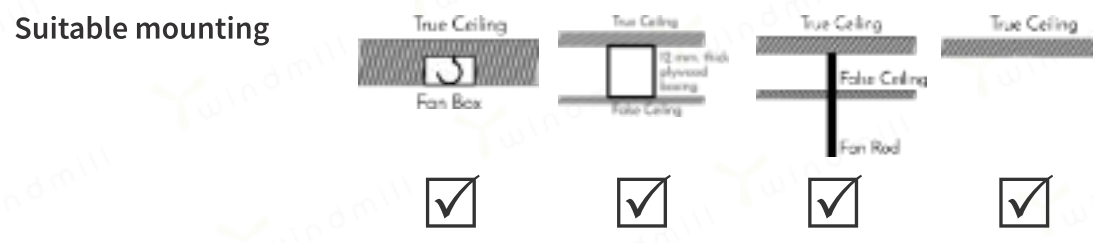

Customisable Sweep sizes (cm.)

105	150
120	
130	
140	

Optional accessories

- 4 speed remote
- reverse operation
- 5 speed wall controller
- slant ceiling mount

Customisable finish for fan motor and metal blades

glossy copper	gold	matt copper	antique bronze	matt pewter	oil rubbed bronze
matt black	matt white (RAL 9010)	bright white (RAL 9003)	brushed aluminum	brushed brass	polished aluminium

Customisable material and finish for fan blades

solid teak wood (matt walnut)	solid teak wood (natural matt)	laminated teak wood (walnut matt)	laminated teak wood (natural matt)	beech wood (natural matt)	wood finish metal



Matt black
Wood finish metal blades

48 INCH 1200 MM	56 INCH 1400 MM
--------------------	--------------------

Standard finish



Matt white

48 INCH 1200 MM	56 INCH 1400 MM
--------------------	--------------------

Standard finish

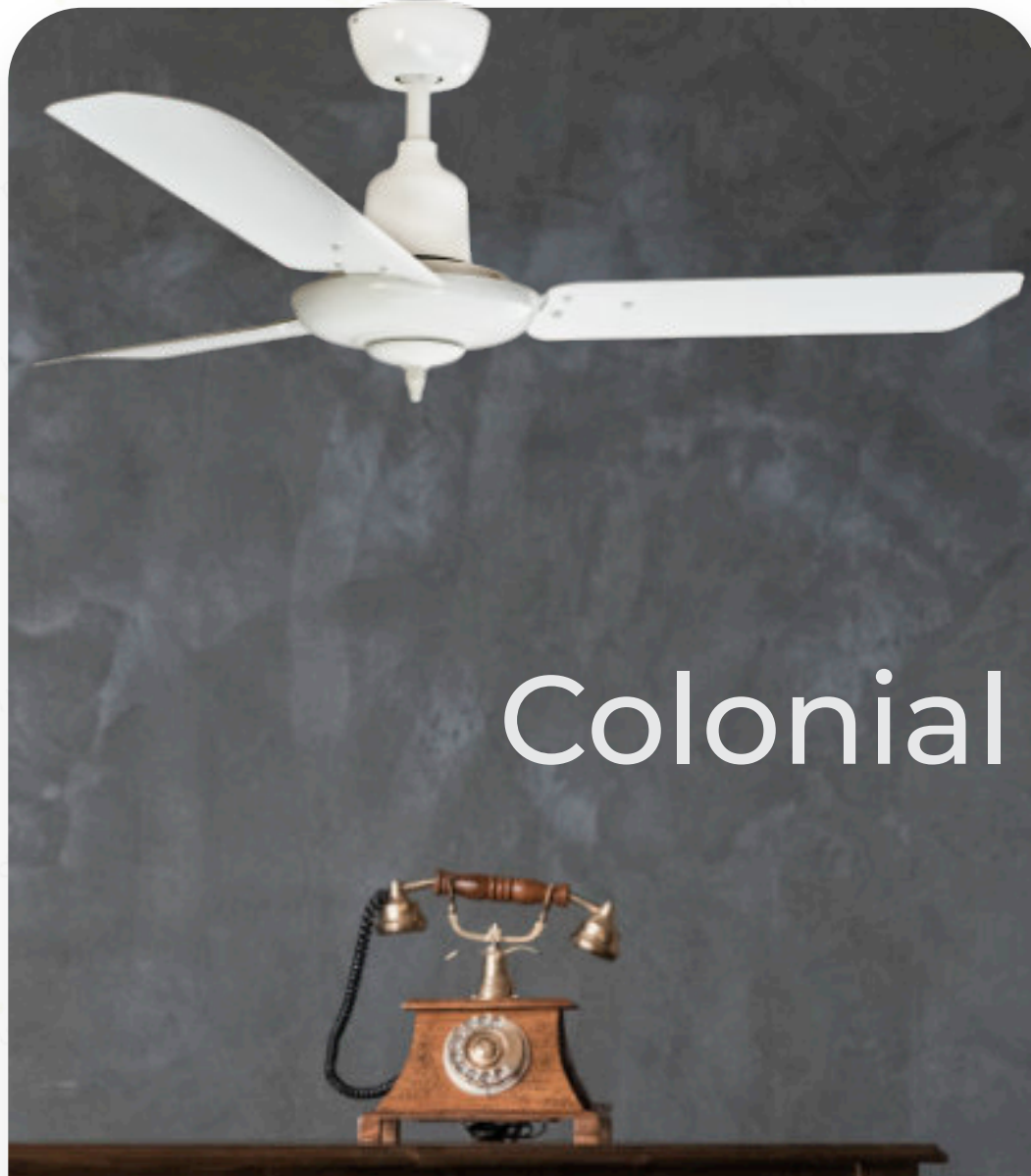

Colonial

The Original Colonial Ceiling fan with an internationally acclaimed design.

These can be seen in French Villas, beach houses, Cafe's etc. Wide blades, silent motor and performance to last a lifetime.

Unlimited combinations of colours, finish and Material; this fan is a Interior designers delight.

300 mm. 400 mm.

Tech specs
 Power: 40 watt 73 watt
 Airflow: 1200 CFM 1800 CFM

Standard features
 AC Motor
 Fully compatible with Automation systems

Working environment
 Suitable for indoor use and covered open spaces
 Suitable for covered outdoor use (select finishes)

Suitable mounting

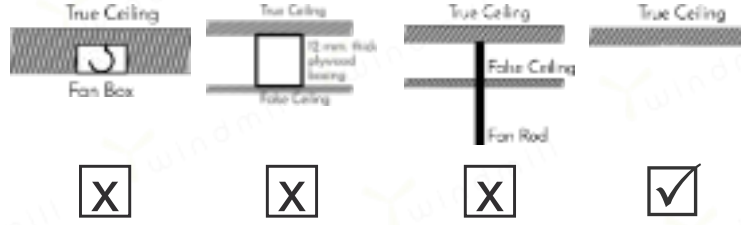

Wall mounted fan / Can also be installed on Ceiling (refer to installation guide)

Dimensions

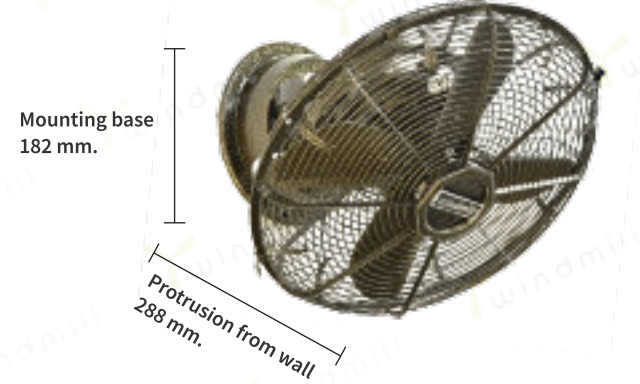

Customisable Sweep sizes (cm.)

30
40

Optional accessories



5 speed wall controller

Customisable finish for fan motor and metal blades



Customisable material and finish for fan blades



wood finish metal



Antique bronze

12 INCH 300 MM 16 INCH 400 MM

Standard finish



Cabin

A Powerful, wall or ceiling mounted fan.
 These are designed, keeping in mind small shops, store rooms ,counters, booths etc. where space is a constraint, this fan can be mounted anywhere.
 Three Speed setting with Pull Chain, Solid State Choke Speed Control.

	400 mm.
Tech specs	Power: 73 watt Airflow: 1800 CFM
Standard features	AC Motor Fully compatible with Automation systems
Working environment	Suitable for indoor use and covered open spaces Suitable for covered outdoor use (select finishes)

Dimensions

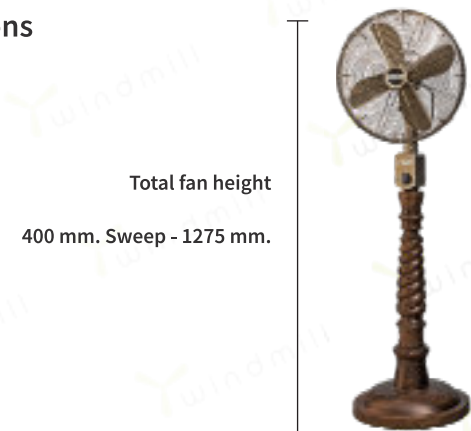

Customisable Sweep sizes (cm.)

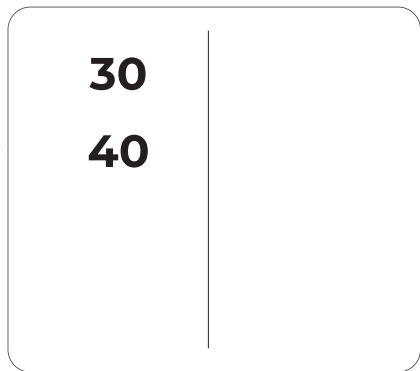

Optional accessories

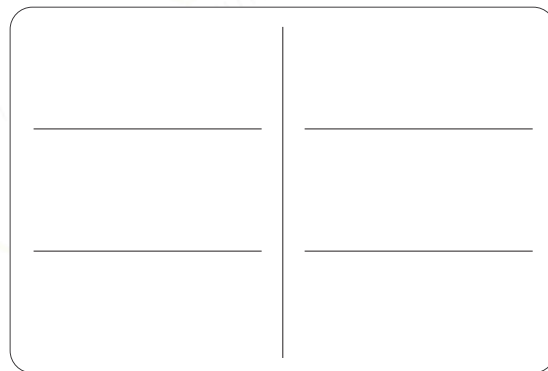

Customisable finish for fan motor and metal blades



Customisable material and finish for fan blades



The all Handmade Solid wood pedestal fan.
Classic design is bound to bring charm and warmth to any room, office or library decor.
Functional design with Oscillation and 3 Speed selector.



1300 mm.

Tech specs
Power: 62 watt
Airflow: 8500

Standard features
AC Motor
Fully compatible with Automation systems

Working environment
Suitable for indoor use and covered open spaces
Suitable for covered outdoor use (select finishes)

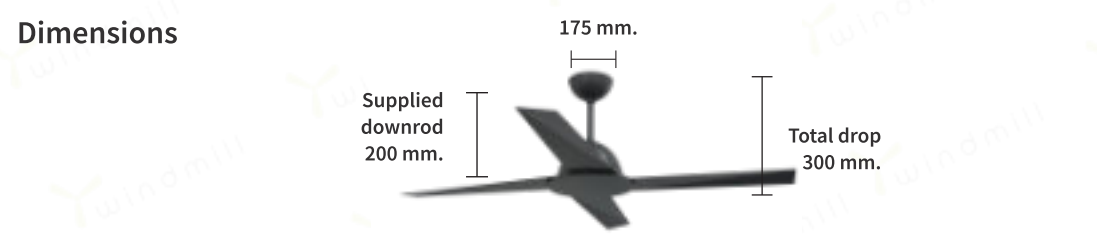
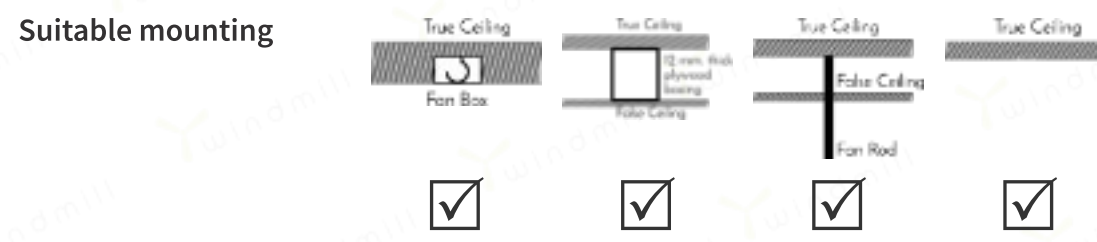

Customisable Sweep sizes (cm.)

120
130

Optional accessories

- 4 speed remote
- reverse operation
- 5 speed wall controller
- slant ceiling mount

Customisable finish for fan motor and metal blades

gold matt copper antique bronze matt pewter oil rubbed bronze

matt black matt white (RAL 9010) bright white (RAL 9003)

Customisable material and finish for fan blades

wood finish metal

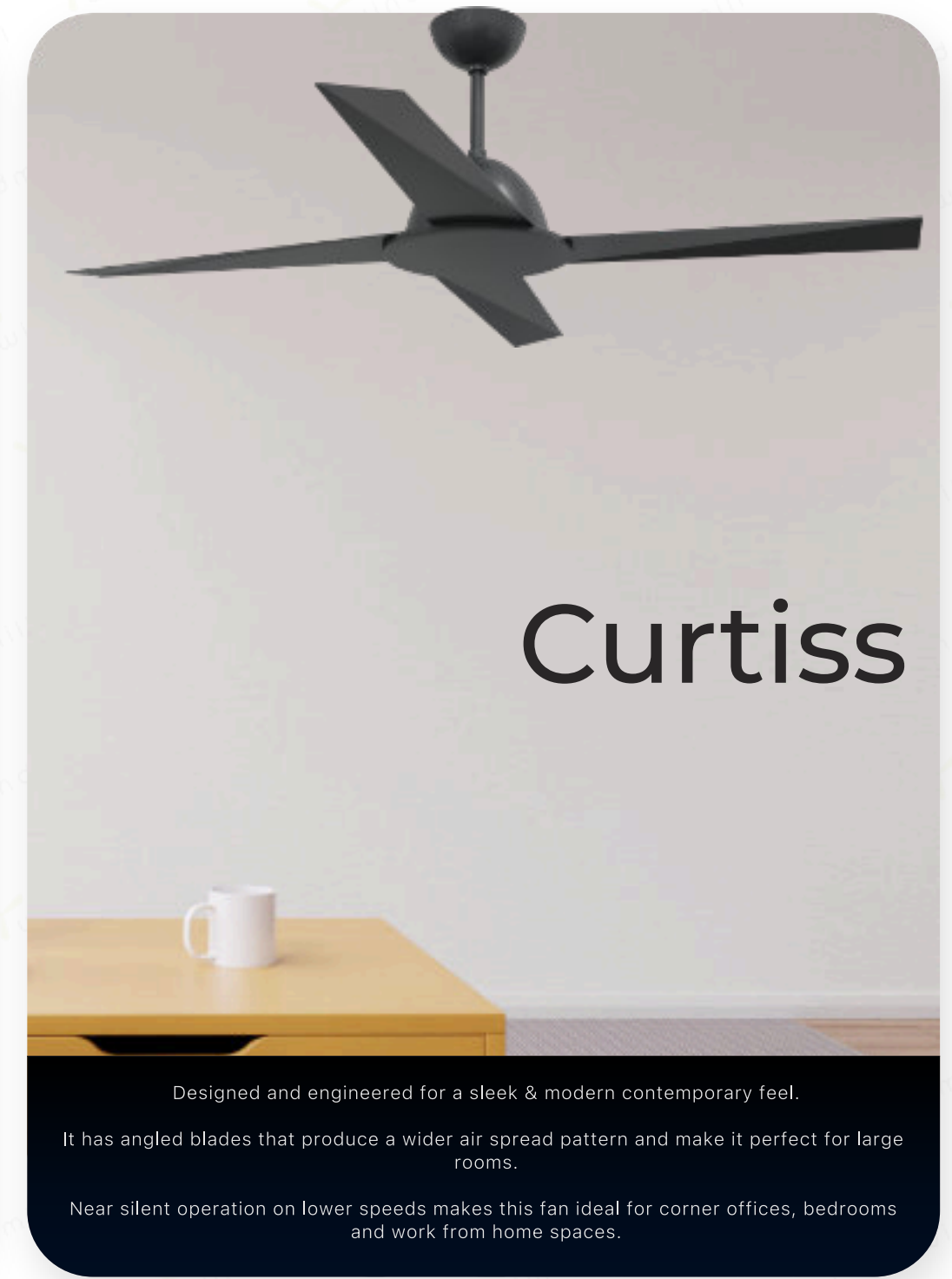

Designed and engineered for a sleek & modern contemporary feel.

It has angled blades that produce a wider air spread pattern and make it perfect for large rooms.

Near silent operation on lower speeds makes this fan ideal for corner offices, bedrooms and work from home spaces.

600 mm. 900 mm.

Tech specs	Power :	40 watt	45 watt
	Airflow :	1800 CFM	2000 CFM

Standard features

- AC Motor
- Fully compatible with Automation systems

Working environment

- Suitable for indoor use and covered open spaces
- Suitable for covered outdoor use (select finishes)
- Suitable for Bathrooms and damp spaces

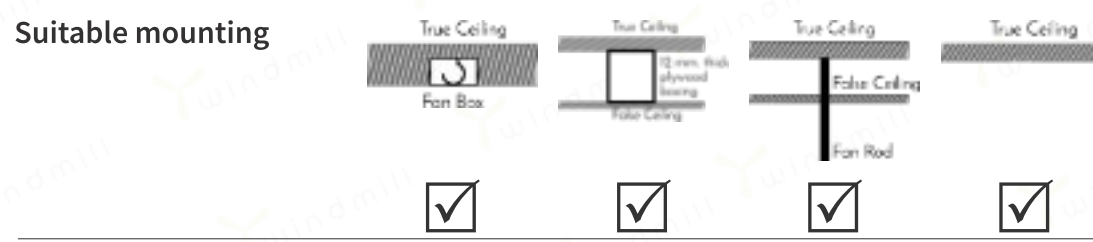

Customisable Sweep sizes (cm.)

60
90

Optional accessories

- 4 speed remote
- reverse operation
- 5 speed wall controller
- slant ceiling mount

Customisable finish for fan motor and metal blades

- gold
- matt copper
- antique bronze
- matt pewter
- oil rubbed bronze
- matt black
- matt white (RAL 9010)
- bright white (RAL 9003)

Customisable material and finish for fan blades

- wood finish metal

Matt Pewter

24 INCH 600 MM 36 INCH 900 MM

Matt White

24 INCH 600 MM 36 INCH 900 MM

Standard finish

Curtiss Jr.

Designed and engineered for a sleek modern contemporary feel.

It has wide angled blades that produce a wider air spread pattern and make it perfect for small rooms or studio spaces.

High speed moisture proof motor makes this fan ideal for Wardrobes, Bathrooms, patios and balconies and small offices.

		1400 mm.	1500 mm.	1600 mm.
Tech specs	Power :	68 watt	75 watt	90 watt
	Airflow :	6500 CFM	7500 CFM	8000 CFM

Standard features

- AC Motor
- Fully compatible with Automation systems

Working environment

- Suitable for indoor use and covered open spaces
- Suitable for covered outdoor use (select finishes)

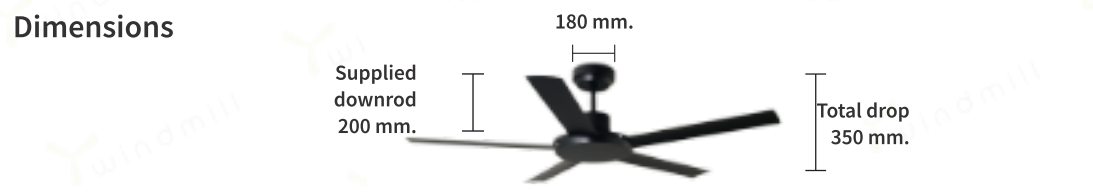
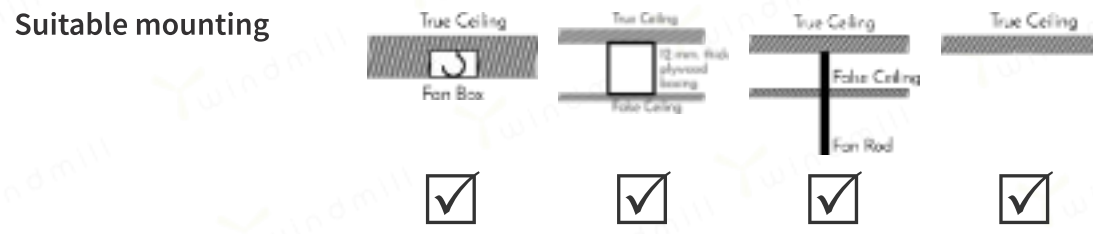

Customisable Sweep sizes (cm.)

120	160
130	
140	
150	

Optional accessories

	4 speed remote		led light kit with remote
	reverse operation		slant ceiling mount
	5 speed wall controller		

Customisable finish for fan motor and metal blades

matt copper	antique bronze	matt pewter	oil rubbed bronze
matt black	matt white (RAL 9010)	bright white (RAL 9003)	

Customisable material and finish for fan blades

laminated teak wood (walnut matt)	laminated teak wood (natural matt)	wood finish metal

Generation is a fan designed for Large spaces. Straight lines, elegant and pure sophistication.

Power house motor in a sleek package, designed to keep the largest of spaces cool with minimal air cutting sound.

The name of the fan gently reminds us of the generation ahead design.

	900 mm.	1050 mm.	1200 mm.	1300 mm.
--	---------	----------	----------	----------

Tech specs	Power: 40 watt	45 watt	50 watt	55 watt
	Airflow: 2500 CFM	4500 CFM	5900 CFM	6500 CFM

Standard features	AC Motor
	Fully compatible with Automation systems

Working environment	Suitable for indoor use and covered open spaces
	Suitable for covered outdoor use (select finishes)

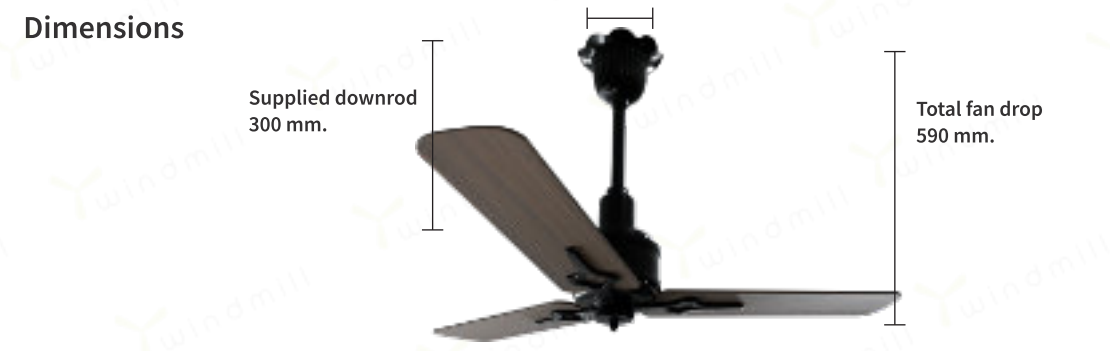
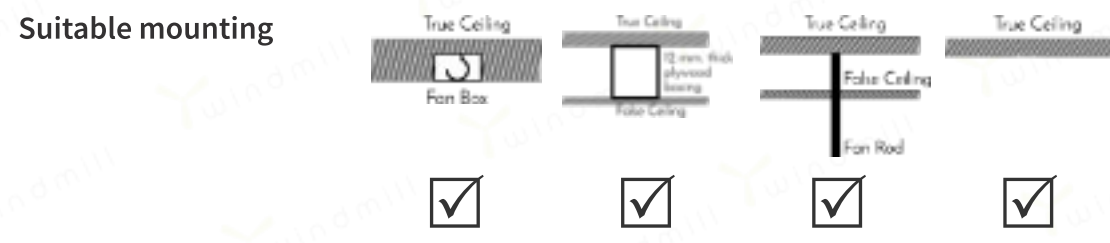

Customisable Sweep sizes (cm.)

- 90
- 105
- 120
- 130

Optional accessories

	4 speed remote
	5 speed wall controller

Customisable finish for fan motor and metal blades

glossy copper	gold	matt copper	antique bronze	matt pewter	oil rubbed bronze
matt black	matt white (RAL 9010)	bright white (RAL 9003)	brushed aluminum	brushed brass	

Customisable material and finish for fan blades

solid teak wood (matt walnut)	solid teak wood (natural matt)	lamine teak wood (walnut matt)	lamine teak wood (natural matt)	beech wood (natural matt)	wood finish metal

Antique bronze
Teak laminate wood
(Walnut matt)

48
INCH
1200 MM

Standard finish

Matt black
Teak laminate wood
(Walnut matt)

48
INCH
1200 MM

Standard finish

Heritage

1910

A fan which can be found in old cafe's and villas; Bold and Timeless.

A marvel of Design which was made in the 1910's now brought back to life, with the same spirit and Class.

Gentle breeze at Slow Speed and Strong wind at full speed - all this without making a sound. Handmade all Cast metal ceiling fan.

	900 mm.	1050 mm.	1200 mm.	1300 mm.
Tech specs	Power: 40 watt	45 watt	50 watt	55 watt
	Airflow: 2500 CFM	4500 CFM	5900 CFM	6500 CFM

Standard features	AC Motor
	Fully compatible with Automation systems

Working environment	Suitable for indoor use and covered open spaces
	Suitable for covered outdoor use (select finishes)

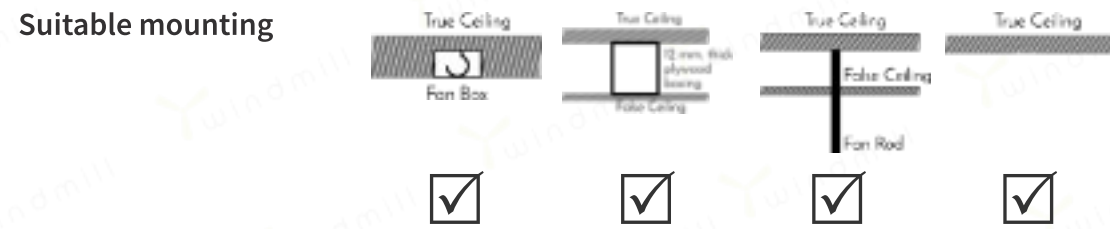

Customisable Sweep sizes (cm.)

- 90
- 105
- 120
- 130

Optional accessories

- 4 speed remote
- 5 speed wall controller

Customisable finish for fan motor and metal blades

Customisable material and finish for fan blades



	900 mm.	1050 mm.	1200 mm.	1300 mm.
--	---------	----------	----------	----------

Tech specs	Power:	40 watt	45 watt	50 watt	55 watt
	Airflow:	2500 CFM	4500 CFM	5900 CFM	6500 CFM

Standard features	AC Motor
	Fully compatible with Automation systems

Working environment	Suitable for indoor use and covered open spaces
	Suitable for covered outdoor use (select finishes)
	Suitable for Bathrooms and damp spaces

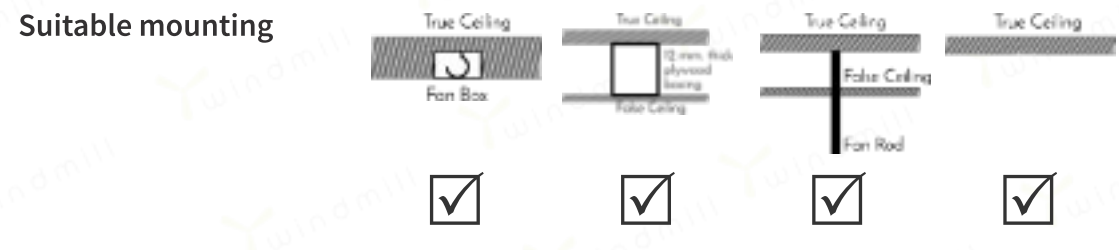

Customisable Sweep sizes (cm.)

- 90
- 105
- 120
- 130

Optional accessories

- 4 speed remote
- 5 speed wall controller

Customisable finish for fan motor and metal blades

matt black	matt white (RAL 9010)	bright white (RAL 9003)	matt copper	antique bronze	matt pewter	oil rubbed bronze

Customisable material and finish for fan blades

solid teak wood (matt walnut)	solid teak wood (natural matt)	laminated teak wood (walnut matt)	laminated teak wood (natural matt)	beech wood (natural matt)	wood finish metal



Matt black
Solid teak wood blades
(Natural matt)

48 INCH
1200 MM



Matt black
Solid teak wood blades
(Walnut matt)

48 INCH
1200 MM

Custom finish



Heritage 1925

A fan which can be found in old cafe's and villas; Bold and Timeless.

A marvel of Design which was made in the 1910's now brought back to life, with the same spirit and Class.

Body mounted hand-carved metal holders provide design flexibility and a classic fan look.

	900 mm.	1050 mm.	1200 mm.	1300 mm.
Tech specs	Power: 40 watt	45 watt	50 watt	55 watt
	Airflow: 2500 CFM	4500 CFM	5900 CFM	6500 CFM
Standard features	AC Motor			
	Fully compatible with Automation systems			

Working environment Suitable for indoor use and covered open spaces

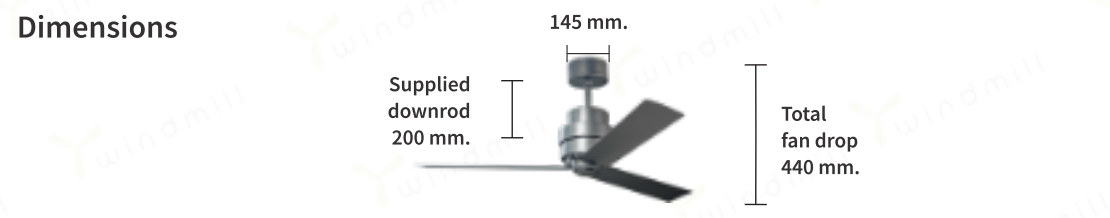
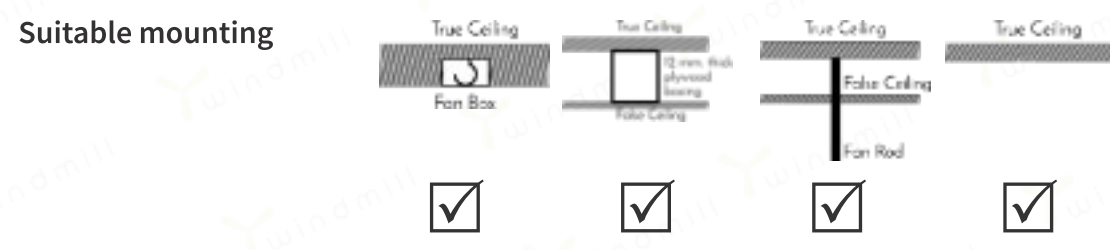

Customisable Sweep sizes (cm.)

90
105
120
130

Optional accessories

- 4 speed remote
- 5 speed wall controller
- slant ceiling mount

Customisable finish for fan motor and metal blades

Customisable material and finish for fan blades

Hornet

HORNET is designed for an Industrial influenced modern look the visible holders and cooling slots give the design an Industrial edge.

Hidden inside is a powerful motor which churns the Air with ease.

	1200 mm.	1400 mm.
Tech specs	Power : 62 watt	65 watt
	Airflow : 6500 CFM	7600 CFM
Standard features	AC Motor	
	Fully compatible with Automation systems	

Working environment Suitable for indoor use and covered open spaces

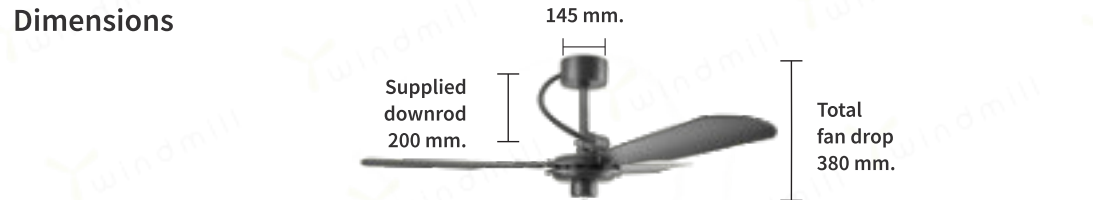
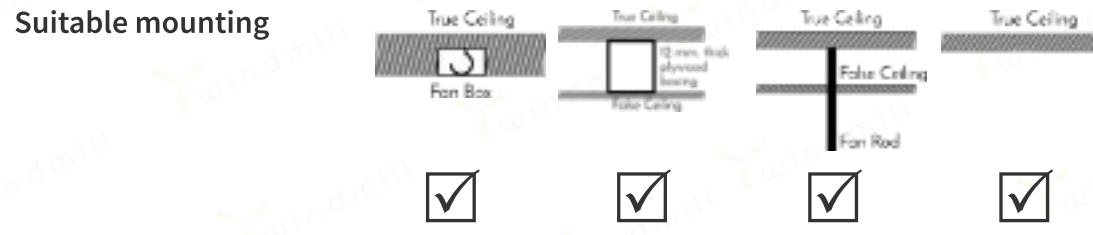

Customisable Sweep sizes (cm.)

120
130
140

Optional accessories

- 4 speed remote
- 5 speed wall controller

Customisable finish for fan motor and metal blades

glossy copper	gold	matt copper	antique bronze	matt pewter	oil rubbed bronze
matt black	matt white (RAL 9010)	bright white (RAL 9003)	brushed aluminum	brushed brass	polished aluminium

Customisable material and finish for fan blades

wood finish metal

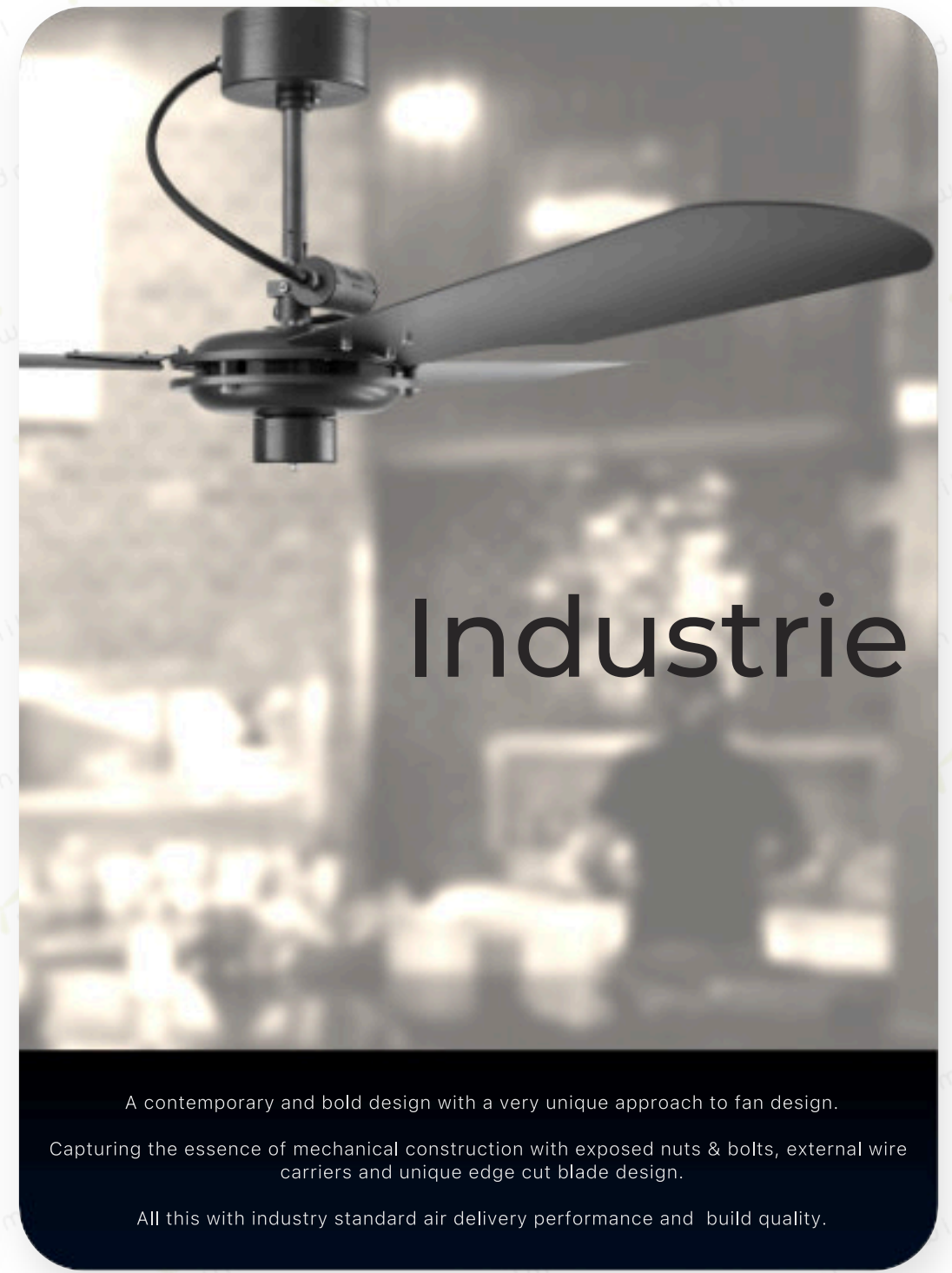

A contemporary and bold design with a very unique approach to fan design. Capturing the essence of mechanical construction with exposed nuts & bolts, external wire carriers and unique edge cut blade design. All this with industry standard air delivery performance and build quality.

1050 mm. 1200 mm. 1300 mm. 1400 mm.

Tech specs	Power :	45 watt	50 watt	55 watt	65 watt
	Airflow :	3800 CFM	5000 CFM	5800 CFM	6900 CFM

Standard features	AC Motor
	Fully compatible with Automation systems

Working environment	Suitable for indoor use and covered open spaces
	Suitable for covered outdoor use (select finishes)

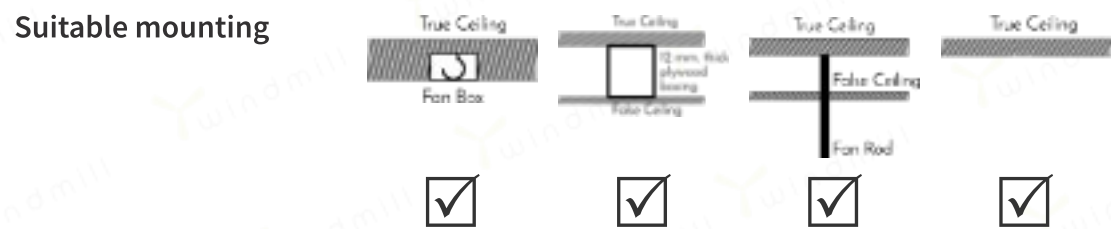

Customisable Sweep sizes (cm.)

- 105**
- 120**
- 130**
- 140**

Optional accessories

- 4 speed remote
- reverse operation
- 5 speed wall controller

Customisable finish for fan motor and metal blades

gold	matt copper	antique bronze	matt pewter	oil rubbed bronze
matt black	matt white (RAL 9010)	bright white (RAL 9003)	brushed aluminum	brushed brass

Customisable material and finish for fan blades

wood finish metal



Designed from "Flat" line collection of the pioneer Italian fan manufacturer Marelli.
 Solid Cast body with liner lines, design influenced heavily from the Art Deco period.
 This was the most sold fan design in the 1920's with a few original pieces still in operation.

1200 mm. 1400 mm. 1500 mm. 1600 mm.

Tech specs	Power :	70 watt	80 watt	85 watt	85 watt
	Airflow :	6500 CFM	7500 CFM	8200 CFM	8500 CFM

Standard features	AC Motor
	Fully compatible with Automation systems

Working environment Suitable for indoor use and covered open spaces
 Suitable for covered outdoor use (select finishes)
 Suitable for Bathrooms and damp spaces

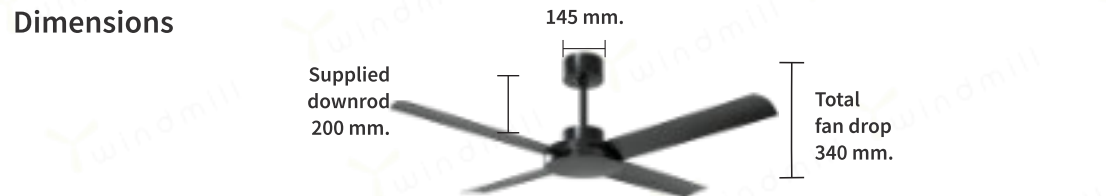
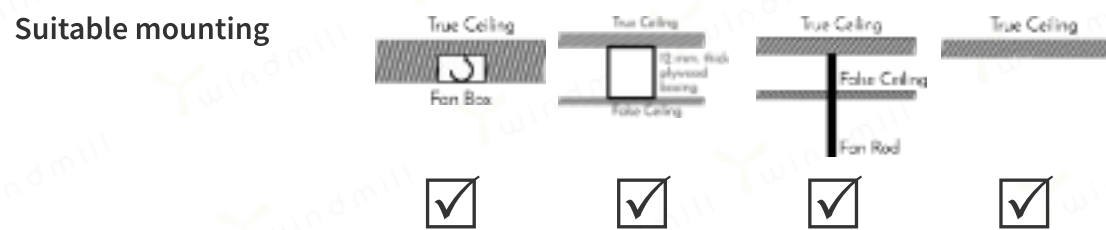

Customisable Sweep sizes (cm.)

105	150
120	160
130	
140	

Optional accessories

	4 speed remote		led light kit with remote
	reverse operation		slant ceiling mount
	5 speed wall controller		

Customisable finish for fan motor and metal blades

glossy copper	gold	matt copper	antique bronze	matt pewter	oil rubbed bronze
matt black	matt white (RAL 9010)	bright white (RAL 9003)	brushed aluminum	brushed brass	polished aluminium

Customisable material and finish for fan blades

wood finish metal

Matt black Wood finish blades
 56 INCH 1400 MM | 60 INCH 1500 MM

Matt black
 56 INCH 1400 MM | 60 INCH 1500 MM

Matt white
 56 INCH 1400 MM | 60 INCH 1500 MM

Matt white Wood finish blades
 56 INCH 1400 MM | 60 INCH 1500 MM

Standard finish

Modena

A fan designed for Large Spaces with minimal design elements, straight lines and organic shapes.

Light blades enable large sweep sizes and more Air volumes.

Die-Cast Aluminium construction with 18 Pole Super Heavy Duty Motor. Suitable for the most demanding and commercial applications.

1300 mm.

Tech specs
Power: 55 watt
Airflow: 7500 CFM

Standard features
AC Motor
Fully compatible with Automation systems

Working environment
Suitable for indoor use and covered open spaces
Suitable for covered outdoor use (select finishes)
Suitable for Bathrooms and damp spaces

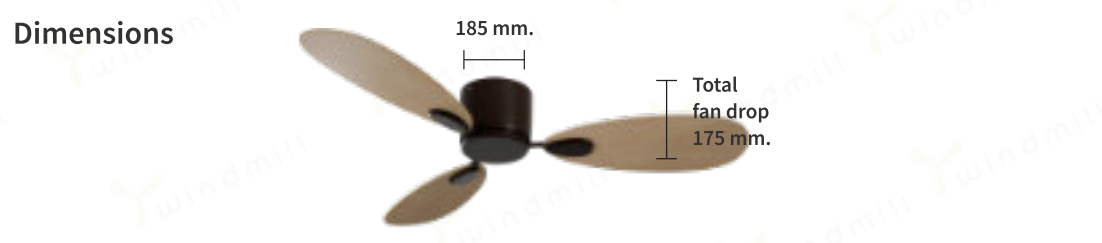
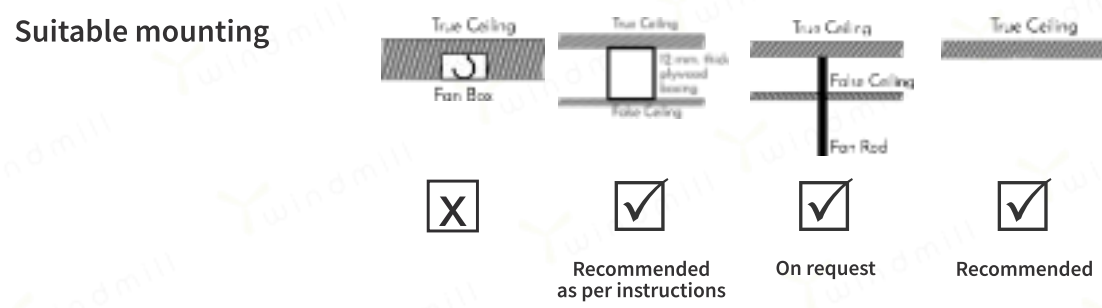

Customisable Sweep sizes (cm.)

105
120
130

Optional accessories

4 speed remote

5 speed wall controller

Customisable finish for fan motor and metal blades

glossy copper, gold, matt copper, antique bronze, matt pewter, oil rubbed bronze, matt black, matt white (RAL 9010), bright white (RAL 9003), brushed aluminum, brushed brass

Customisable material and finish for fan blades

lamine teak wood (walnut matt), lamine teak wood (natural matt), beech wood (natural matt)

Matt White
Solid beech wood propeller (Natural Matt)
52 INCH 1300 MM
Standard finish

Matt Pewter
Solid beech wood propeller (Natural Matt)
52 INCH 1300 MM
Standard finish

Matt Black
Solid beech wood propeller (Natural Matt)
52 INCH 1300 MM
Custom finish

Oil rubbed bronze
Solid beech wood propeller (Natural Matt)
52 INCH 1300 MM
Custom finish

October hugger

HUGGER (Flush Ceiling Mounting) designed to install ceiling fan for Low Height ceilings, without compromise on air delivery.

Ultra sleek, modern lines coupled with Areodynamic carved Solid beech wood propeller. Best in performance and luxury with silent Air delivery and complete compatiability with all automation systems.

1200 mm. 1400 mm. 1500 mm. 1600 mm.

Tech specs	Power :	70 watt	80 watt	85 watt	90 watt
	Airflow :	6500 CFM	7500 CFM	8000 CFM	8500 CFM

Standard features	AC Motor
	Fully compatible with Automation systems

Working environment	Suitable for indoor use and covered open spaces
	Suitable for covered outdoor use (select finishes)
	Suitable for Bathrooms and damp spaces

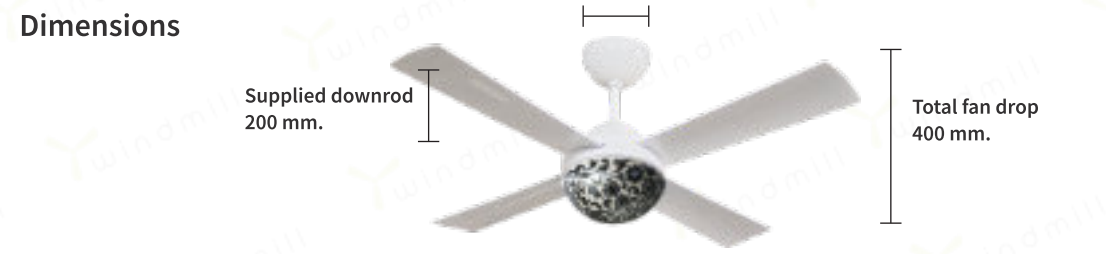
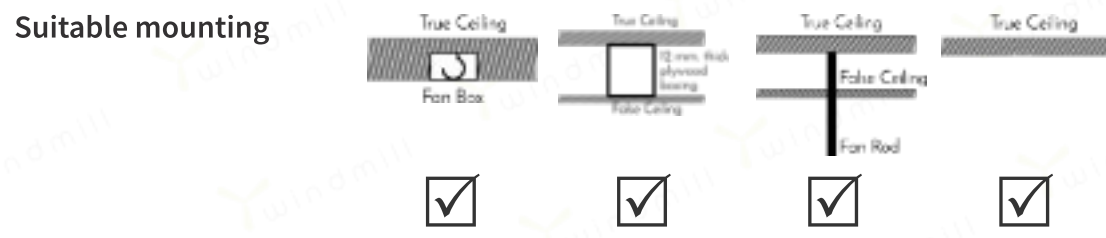

Customisable Sweep sizes (cm.)

120	160
130	
140	
150	

Optional accessories

	4 speed remote		slant ceiling mount
	reverse operation		
	5 speed wall controller		

Customisable finish for fan motor and metal blades

glossy copper	gold	matt copper	antique bronze	matt pewter	oil rubbed bronze
matt black	matt white (RAL 9010)	bright white (RAL 9003)	brushed aluminum	brushed brass	

Customisable material and finish for fan blades

laminated teak wood (walnut matt)	laminated teak wood (natural matt)	beech wood (natural matt)	wood finish metal

Bright White Jaipur Blue pottery bowl (Blue fill)
56 INCH 1400 MM

Bright White Jaipur Blue pottery bowl (Black fill)
56 INCH 1400 MM

Custom finish

Custom finish

Persia

The art of Blue Pottery is a culmination of Chinese glazing and Persian decorative arts, bought to India in 14th Century.

In 19th Century this art was bought to Jaipur by ruler Sawai Ram Singh II.

"Persia" pays tribute to this eye-catching traditional art of Jaipur by using it for the First time ever with a ceiling fan.

	900 mm.	1050 mm.	1200 mm.	1300 mm.
Tech specs	Power: 40 watt	45 watt	50 watt	55 watt
	Airflow: 2500 CFM	4500 CFM	5900 CFM	6500 CFM

Standard features	AC Motor
	Fully compatible with Automation systems

Working environment Suitable for indoor use and covered open spaces
 Suitable for covered outdoor use (select finishes)
 Suitable for Bathrooms and damp spaces

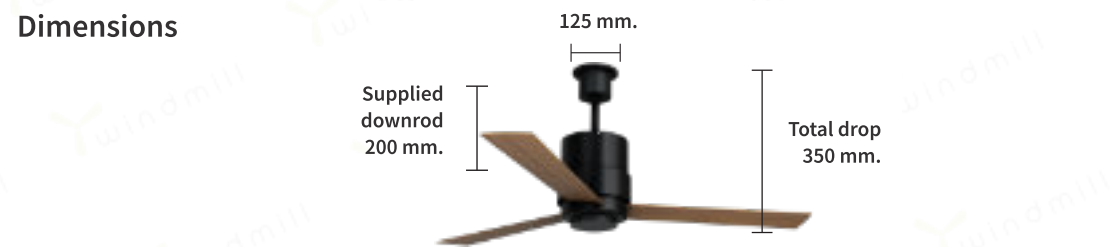
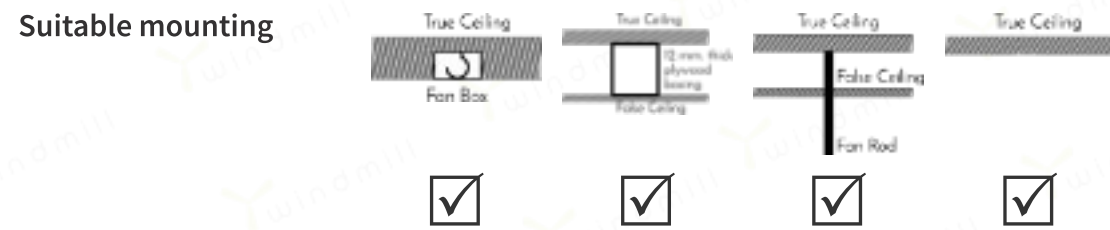

Customisable Sweep sizes (cm.)

- 90
- 105
- 120
- 130

Optional accessories

4 speed remote	led light kit with remote
reverse operation	slant ceiling mount
5 speed wall controller	

Customisable finish for fan motor and metal blades

glossy copper	gold	matt copper	antique bronze	matt pewter	oil rubbed bronze
matt black	matt white (RAL 9010)	bright white (RAL 9003)	brushed aluminum	brushed brass	

Customisable material and finish for fan blades

solid teak wood (matt walnut)	solid teak wood (natural matt)	laminated teak wood (walnut matt)	laminated teak wood (natural matt)	beech wood (natural matt)	wood finish metal
-------------------------------	--------------------------------	-----------------------------------	------------------------------------	---------------------------	-------------------

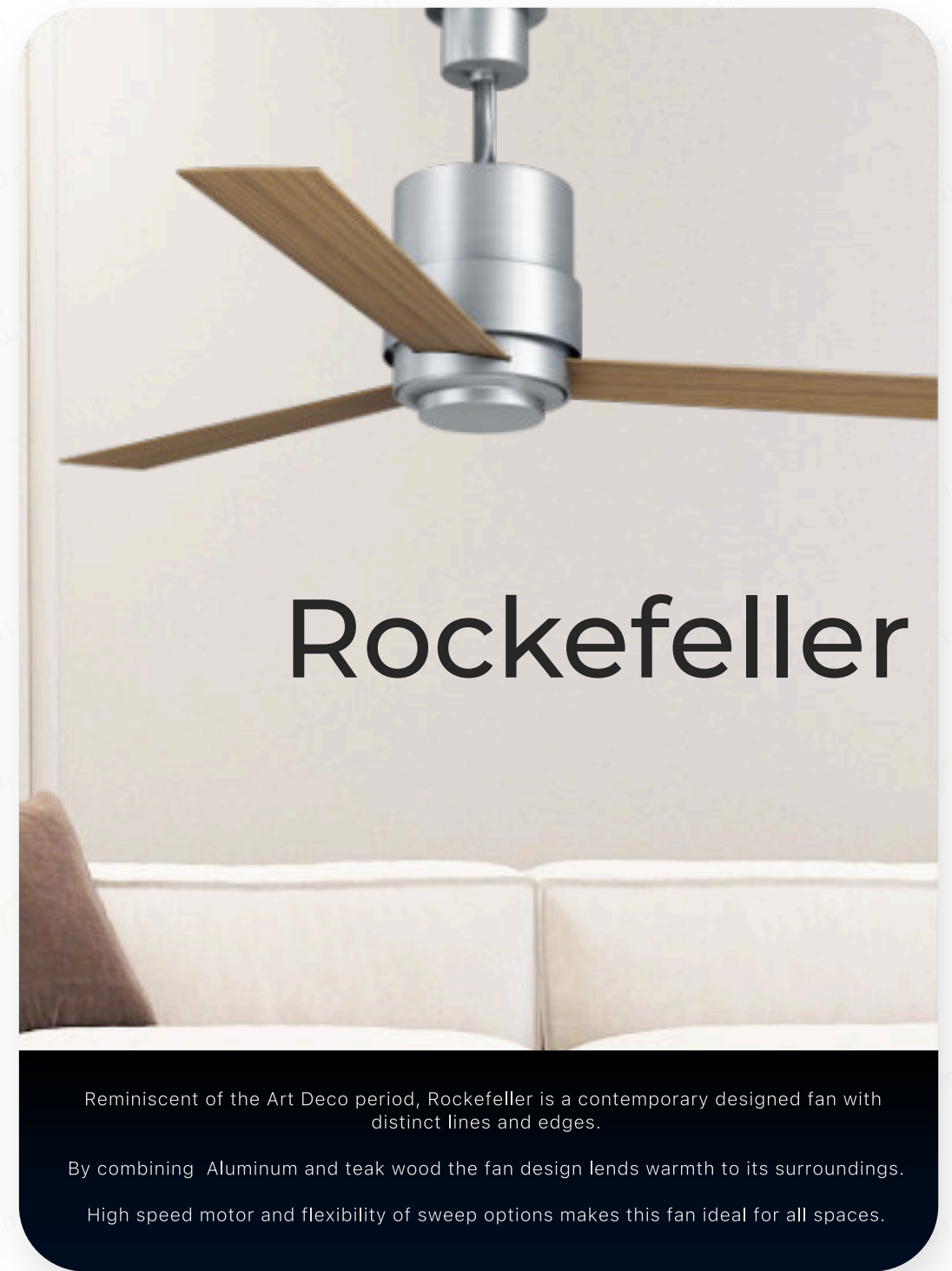

Reminiscent of the Art Deco period, Rockefeller is a contemporary designed fan with distinct lines and edges.
 By combining Aluminum and teak wood the fan design lends warmth to its surroundings.
 High speed motor and flexibility of sweep options makes this fan ideal for all spaces.

	900 mm.	1050 mm.	1200 mm.	1300 mm.
Tech specs	Power: 40 watt	45 watt	50 watt	55 watt
	Airflow: 2500 CFM	4500 CFM	5900 CFM	6500 CFM

Standard features

- AC Motor
- Fully compatible with Automation systems

Working environment

- Suitable for indoor use and covered open spaces
- Suitable for covered outdoor use (select finishes)
- Suitable for Bathrooms and damp spaces

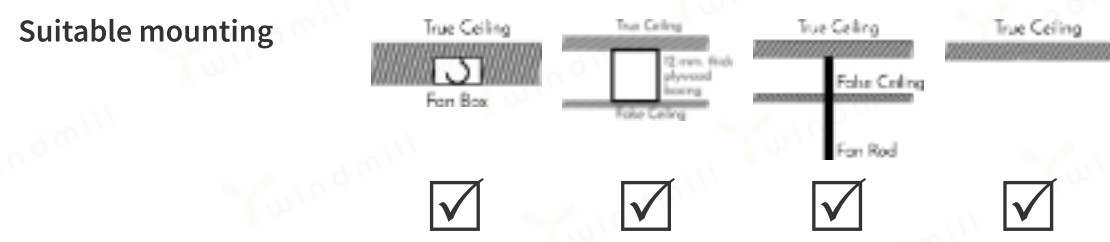

Customisable Sweep sizes (cm.)

90
105
120
130

Optional accessories

- 4 speed remote
- led light kit with remote
- 5 speed wall controller

Customisable finish for fan motor and metal blades

glossy copper	gold	matt copper	antique bronze	matt pewter	oil rubbed bronze
matt black	matt white (RAL 9010)	bright white (RAL 9003)	brushed aluminum	brushed brass	matt silver

Customisable material and finish for fan blades

solid teak wood (matt walnut)	solid teak wood (natural matt)	lamine teak wood (walnut matt)	lamine teak wood (natural matt)	beech wood (natural matt)	wood finish metal

Matt Black Laminated Teak wood (Walnut Matt finish)
48 INCH 1200 MM

Matt white
48 INCH 1200 MM

Matt Pewter
48 INCH 1200 MM

Matt Silver Laminated Teak wood (Walnut Matt finish)
48 INCH 1200 MM

Standard finish
Standard finish
Custom finish
Custom finish

Rockefeller hugger

Reminiscent of the Art Deco period, Rockefeller is a contemporary designed fan with distinct lines and edges.

By combining Aluminum and teak wood the fan design lends warmth to its surroundings.

High speed motor and flexibility of sweep options makes this fan ideal for all spaces.

home

	1300 mm.
Tech specs	Power : 55 watt Airflow : 8500 CFM
Standard features	AC Motor Fully compatible with Automation systems

Working environment Suitable for indoor use and covered open spaces
Suitable for covered outdoor use (select finishes)

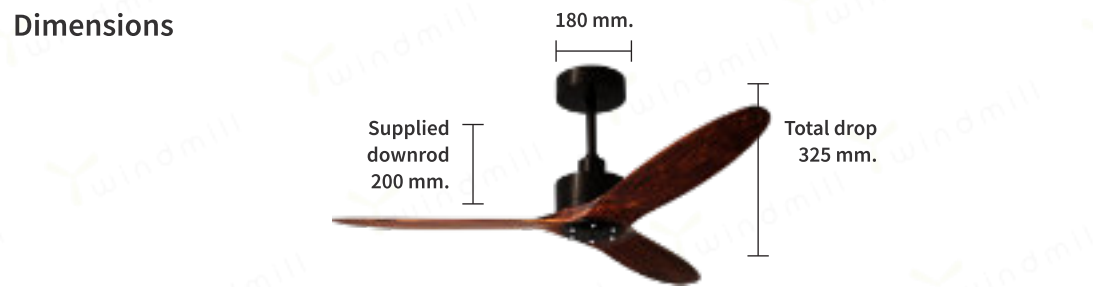
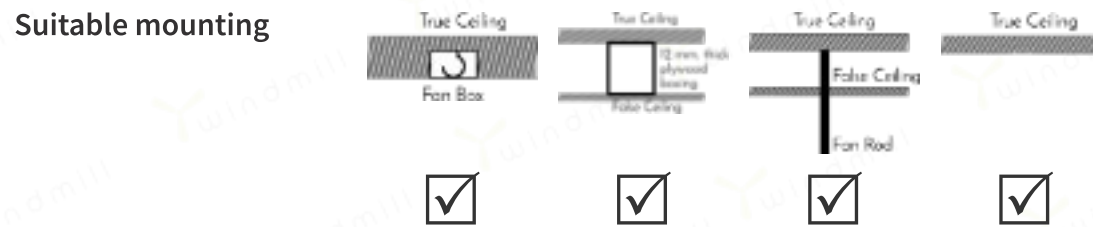

Customisable Sweep sizes (cm.)

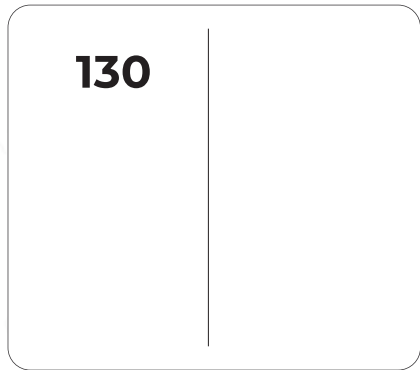

Optional accessories

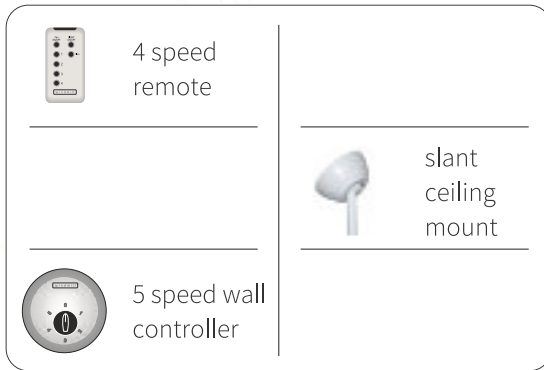

Customisable finish for fan motor and metal blades



Customisable material and finish for fan blades

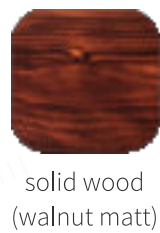

Brushed Aluminum
Solid wood propellers (Dark Matt finish)
52 INCH
1300 MM

Oil Rubbed Bronze
Solid wood propellers (Dark Matt finish)
52 INCH
1300 MM

Polished Aluminum
Solid wood propellers (Dark Matt finish)
52 INCH
1300 MM

Standard finish
Standard finish
Custom finish

Sabre

A finely designed ceiling fan that is a work of art in its own right. A high-speed fan with great air delivery.

Sabre comes with Carved wood propeller blades that look like airplane wings providing an alternative spin on this modern design piece.

Handcrafted and hand-polished in premium solid wood dark matt finish

1050 mm. 1200 mm. 1300 mm.

Tech specs	Power:	45 watt	50 watt	55 watt
	Airflow:	3800 CFM	5000 CFM	5800 CFM

Standard features

- AC Motor
- Fully compatible with Automation systems

Working environment

- Suitable for indoor use and covered open spaces
- Suitable for covered outdoor use (select finishes)

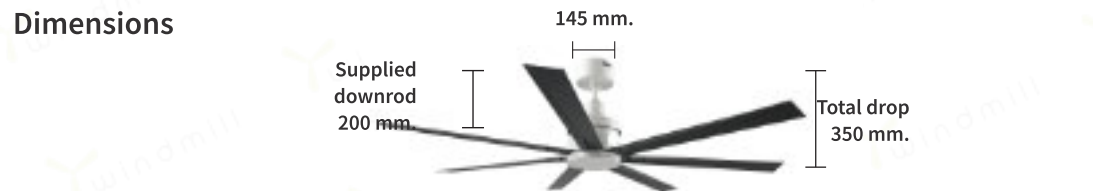
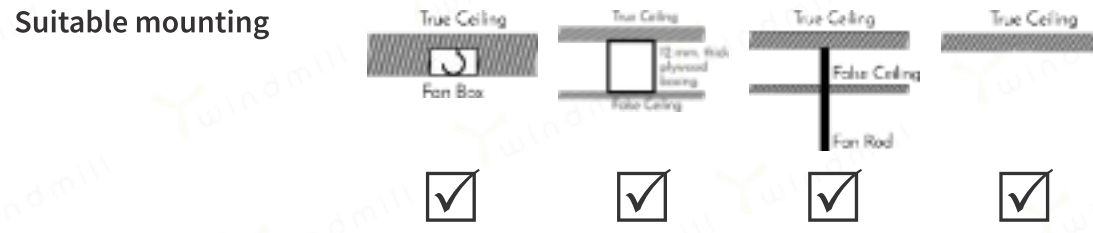

Customisable Sweep sizes (cm.)

105
120
130

Optional accessories

- 4 speed remote
- 5 speed wall controller
- led light kit with remote
- slant ceiling mount

Customisable finish for fan motor and metal blades

- glossy copper
- gold
- matt copper
- antique bronze
- matt pewter
- oil rubbed bronze
- matt black
- matt white (RAL 9010)
- bright white (RAL 9003)
- brushed aluminum
- brushed brass

Customisable material and finish for fan blades

- solid teak wood (matt walnut)
- solid teak wood (natural matt)
- lamine teak wood (walnut matt)
- lamine teak wood (natural matt)
- beech wood (natural matt)
- wood finish metal

Custom finish

Matt pewter
Solid teak wood blades
(Walnut matt finish)

52 INCH
1300 MM

Standard finish

Matt white
Solid teak wood blades
(Walnut matt finish)

52 INCH
1300 MM

Standard finish

Matt black
Matt black blades

52 INCH
1300 MM

Sceptre

Super efficient 7 blade design, inspired from Turbines blades; churning out large volumes of air in a compact size.

Suitable for commercial, hospitality and residential applications. Ideal for dining, meeting or living rooms.

1400 mm. 1500 mm.

Tech specs	Power :	110 watt	140 watt
	Airflow :	7500 CFM	8200 CFM

Standard features	AC Motor
	Fully compatible with Automation systems

Working environment	Suitable for indoor use and covered open spaces
	Suitable for covered outdoor use (select finishes)

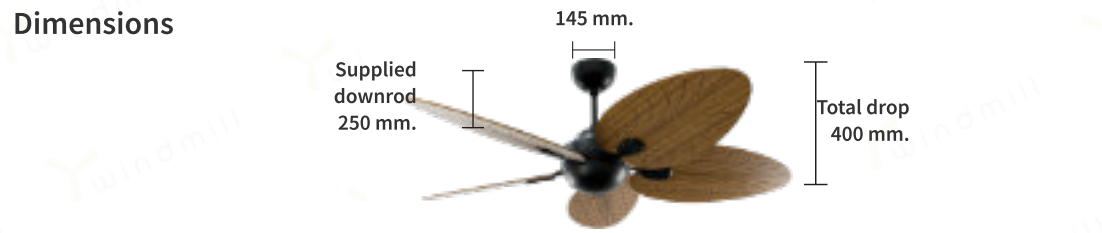
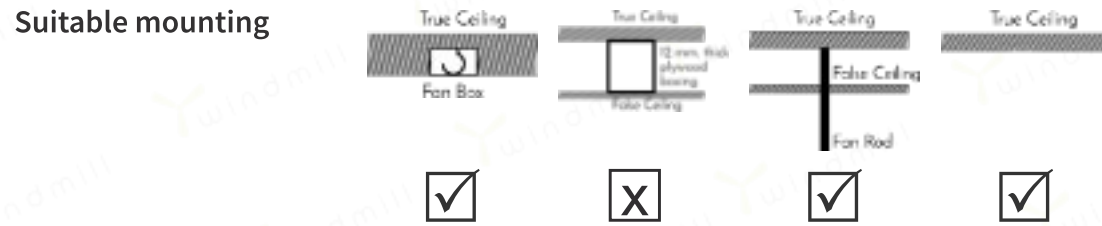

Customisable Sweep sizes (cm.)

140
150

Optional accessories

4 speed remote

5 speed wall controller

slant ceiling mount

Customisable finish for fan motor and metal blades

Customisable material and finish for fan blades

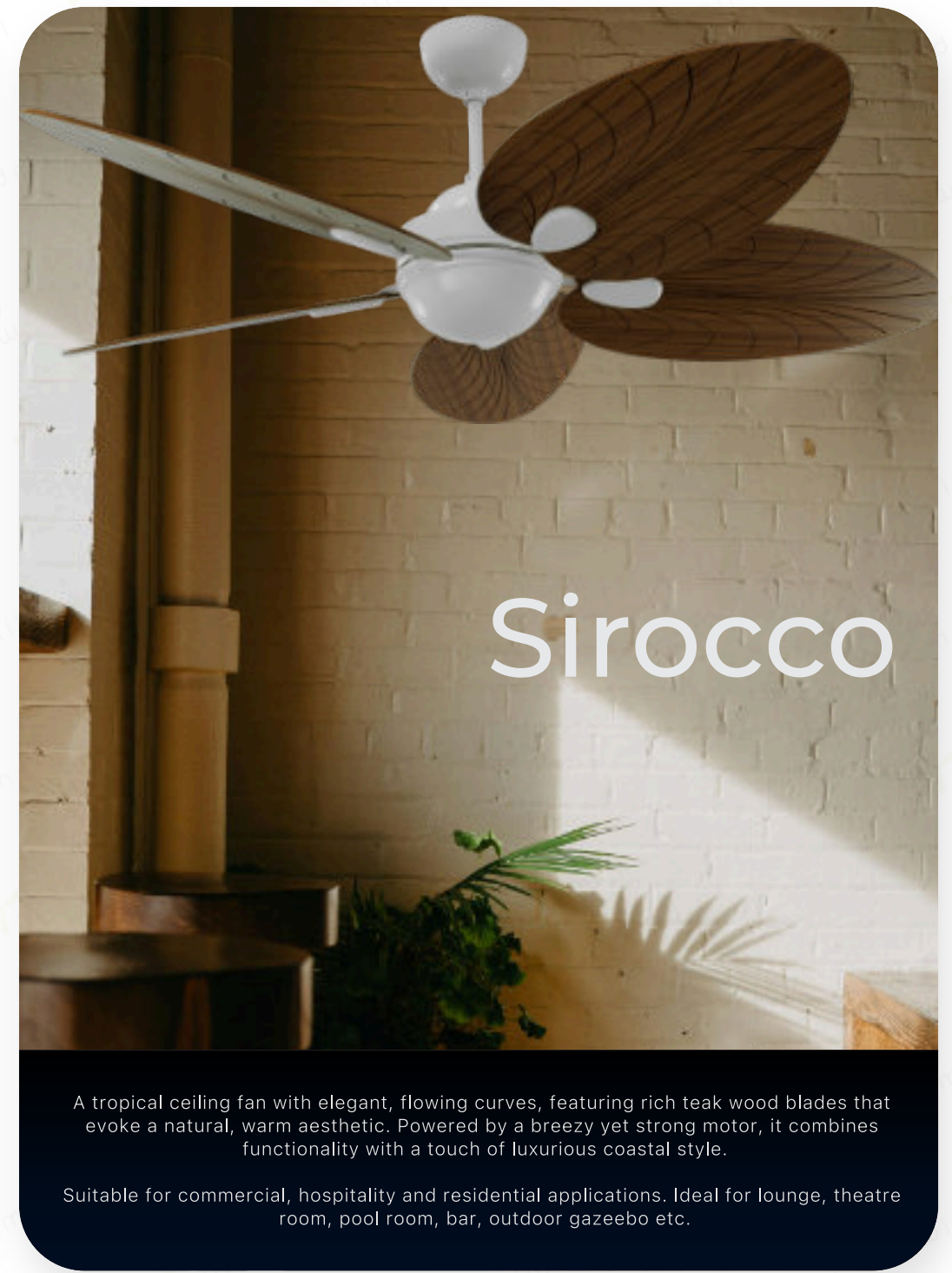

Sirocco

A tropical ceiling fan with elegant, flowing curves, featuring rich teak wood blades that evoke a natural, warm aesthetic. Powered by a breezy yet strong motor, it combines functionality with a touch of luxurious coastal style.

Suitable for commercial, hospitality and residential applications. Ideal for lounge, theatre room, pool room, bar, outdoor gazebo etc.

1300 mm. 1400 mm. 1800 mm.

Tech specs	Power:	67 watt	75 watt	90 watt
	Airflow:	8600 CFM	9500 CFM	10000 CFM

Standard features

- AC Motor
- Fully compatible with Automation systems

Working environment

- Suitable for indoor use and covered open spaces
- Suitable for covered outdoor use (select finishes)

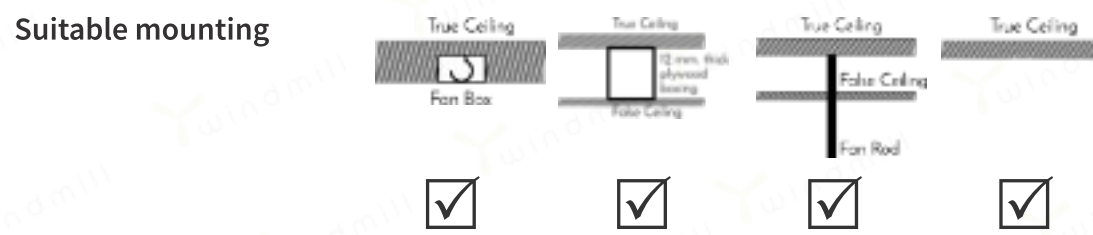

Customisable Sweep sizes (cm.)

120
130
140
180

Optional accessories

- 4 speed remote
- reverse operation
- 5 speed wall controller
- slant ceiling mount

Customisable finish for fan motor and metal blades

- glossy copper
- gold
- matt copper
- antique bronze
- matt pewter
- oil rubbed bronze
- matt black
- matt white (RAL 9010)
- bright white (RAL 9003)
- brushed aluminum
- brushed brass
- polished aluminium

Customisable material and finish for fan blades

- beech wood (natural matt)
- birch wood (walnut matt)

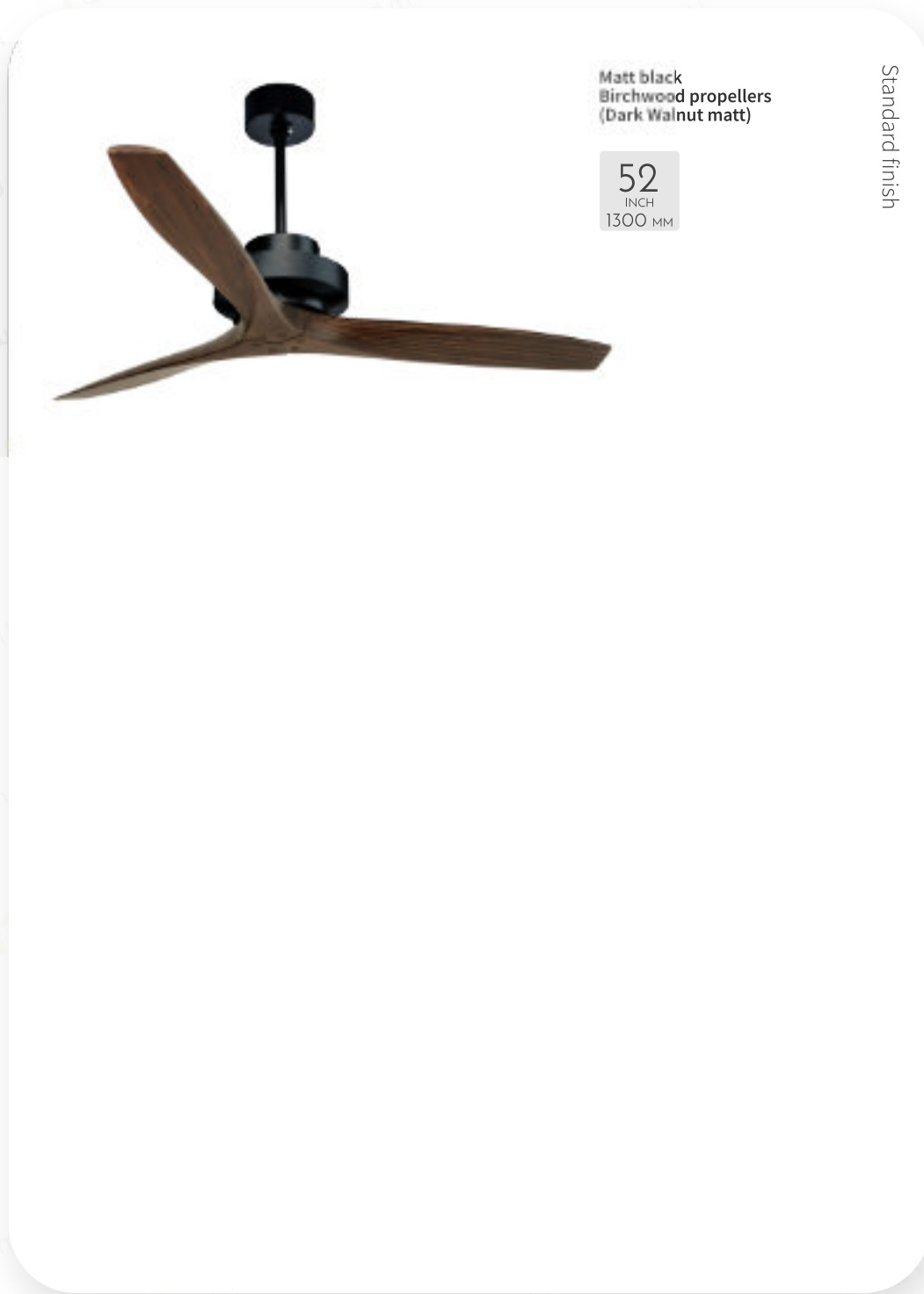

Named from a World War II fighter plane, the propellers are Hand-Carved from a solid piece of Wood.

Symmetrically designed motor, aesthetically elegant yet powerful enough to generate a storm.

1300 mm. 1400 mm.

Tech specs	Power:	67 watt	75watt
	Airflow:	8600 CFM	9500 CFM

Standard features	AC Motor
	Fully compatible with Automation systems

Working environment	Suitable for indoor use and covered open spaces
	Suitable for covered outdoor use (select finishes)

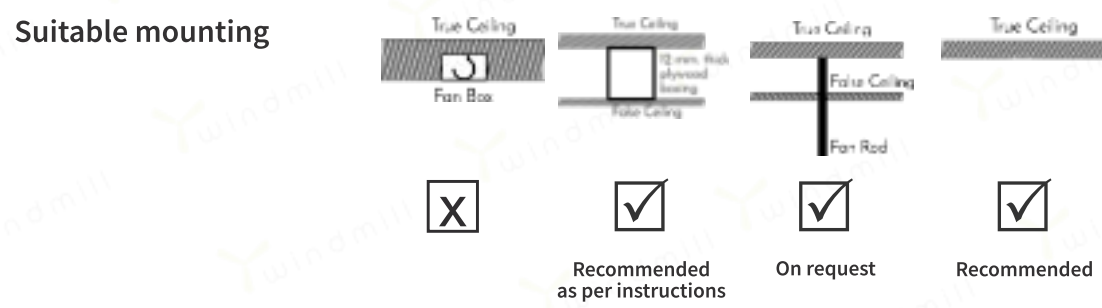

Customisable Sweep sizes (cm.)

- 120
- 130
- 140

Optional accessories

4 speed remote	slant ceiling mount
5 speed wall controller	

Customisable finish for fan motor and metal blades

glossy copper	gold	matt copper	antique bronze	matt pewter	oil rubbed bronze
matt black	matt white (RAL 9010)	bright white (RAL 9003)	brushed aluminum	brushed brass	polished aluminium

Customisable material and finish for fan blades

beech wood (natural matt)	birch wood (walnut matt)
---------------------------	--------------------------

	Standard finish
	Custom finish
	Custom finish

Spitfire hugger

HUGGER (Flush Ceiling Mounting) designed to install ceiling fan for Low Height ceilings, without compromise on air delivery.

Named from a World War II fighter plane, the propellers are Hand-Carved from a solid piece of Wood.

Symmetrically designed motor, aesthetically elegant yet powerful enough to generate a storm.

		1800 mm.	2100 mm.
Tech specs	Power :	140 watt	150 watt
	Airflow :	10000 CFM	14600 CFM

Standard features

- AC Motor
- Fully compatible with Automation systems
- 4 speed RF Remote control

Working environment

- Suitable for indoor use and covered open spaces
- Suitable for covered outdoor use (select finishes)

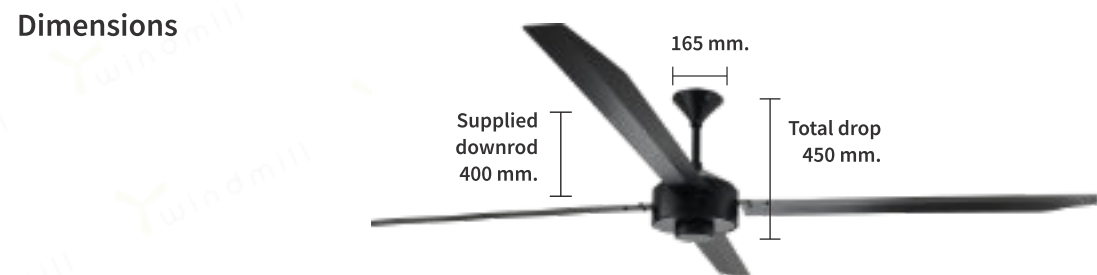
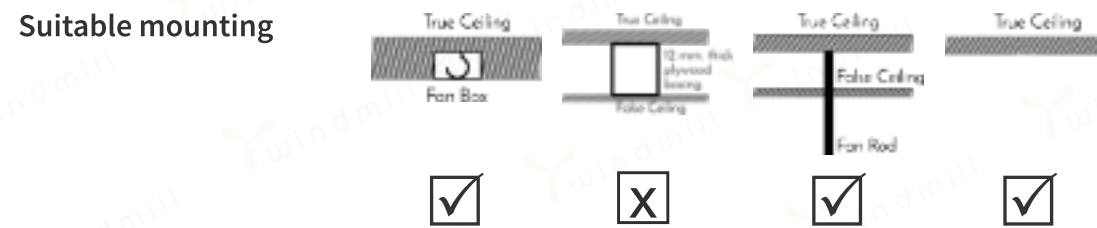

Customisable Sweep sizes (cm.)

160
170
180
210

Optional accessories

4 speed remote

Customisable finish for fan motor and metal blades

matt copper antique bronze matt pewter oil rubbed bronze matt black matt white (RAL 9010)

bright white (RAL 9003)

Customisable material and finish for fan blades

wood finish metal



Stark is the most powerful fan Windmill has to offer.

It can be used to cool Restaurants, Hotel lobbies, Lounge spaces, Retail showrooms, Commercial spaces and Residential spaces.

Modern design with light industrial elements; all of which can be customised to suit any project.

1200 mm.

Tech specs	Power :	50 watt
	Airflow :	6500 CFM

Standard features	AC Motor
	Fully compatible with Automation systems

Working environment	Suitable for indoor use and covered open spaces
	Suitable for covered outdoor use (select finishes)

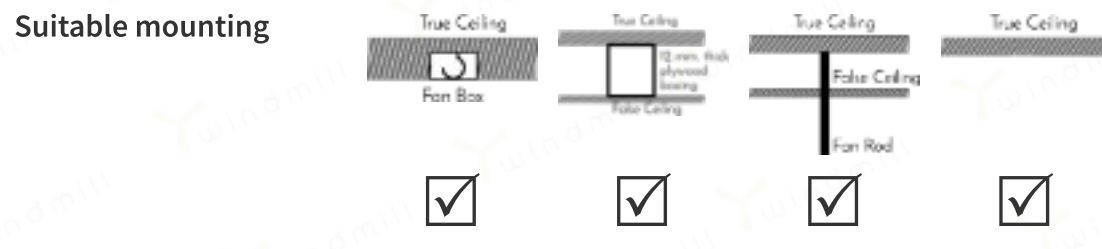

Customisable Sweep sizes (cm.)

- 90**
- 105**
- 120**
- 130**

Optional accessories

	4 speed remote		slant ceiling mount
	5 speed wall controller		

Customisable finish for fan motor and metal blades

glossy copper	gold	matt copper	antique bronze	matt pewter	oil rubbed bronze
matt black	matt white (RAL 9010)	bright white (RAL 9003)	brushed aluminum	brushed brass	

Customisable material and finish for fan blades

wood finish metal



A look inspired from a Stealth aircraft; sharp bends and straight lines.

Energy saving AC technology brings about the best in performance and efficiency in a fan.

Wide air spread pattern with smooth air movement in low speeds makes this ideal for offices, bedrooms and work spaces.

1200 mm.

Tech specs
Power: 50 watt
Airflow: 6500 CFM

Standard features
AC Motor
Fully compatible with Automation systems

Working environment
Suitable for indoor use and covered open spaces
Suitable for covered outdoor use (select finishes)

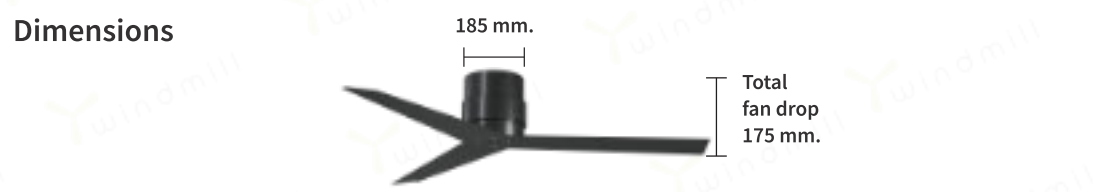
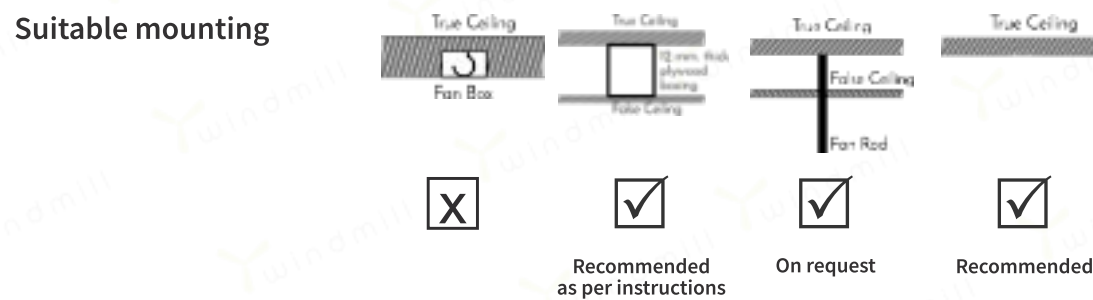

Customisable Sweep sizes (cm.)

90
105
120
130

Optional accessories

4 speed remote
5 speed wall controller
slant ceiling mount

Customisable finish for fan motor and metal blades

glossy copper, gold, matt copper, antique bronze, matt pewter, oil rubbed bronze, matt black, matt white (RAL 9010), bright white (RAL 9003), brushed aluminum, brushed brass

Customisable material and finish for fan blades

wood finish metal

Matt white
48 INCH 1200 MM
Standard finish

Matt black
48 INCH 1200 MM
Standard finish

Matt pewter
48 INCH 1200 MM
Custom finish

Stealth hugger

HUGGER (Flush Ceiling Mounting) designed to install ceiling fan for Low Height ceilings, without compromise on air delivery.

A look inspired from a Stealth aircraft; sharp bends and straight lines.

AC technology brings about the best in performance with complete Automation compatibility.

1400 mm.

Tech specs
Power: 70 watt
Airflow: 6500 CFM

Standard features
AC Motor
Fully compatible with Automation systems
3 speed controller

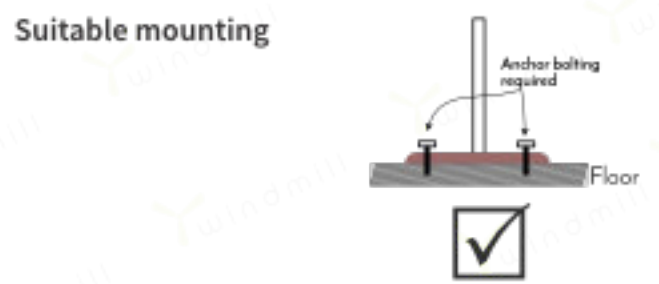

IP60
Indoor rated

Customisable Sweep sizes (cm.)

140
150

Optional accessories

4 speed remote

Customisable finish for fan motor and metal blades

matt copper, antique bronze, matt pewter, oil rubbed bronze, matt black, matt white (RAL 9010)

Customisable material and finish for fan blades

solid teak wood (matt walnut), solid teak wood (natural matt), laminate teak wood (walnut matt), laminate teak wood (natural matt), beech wood (natural matt), wood finish metal



Riviera can be seen in Grand Ballrooms with high ceilings, cozy patios & sunny decks.
Curved blades elegantly spread the cool air down as the fan whirrs in silence.
All metal powder painted parts, ensures the fan stands the harsh heat, cold and damp winds.



IP60
Indoor rated

home

1400 mm.

Tech specs
Power: 70 watt
Airflow: 7800 CFM

Standard features
AC Motor
5 speed wall controller 
Fully compatible with Automation systems

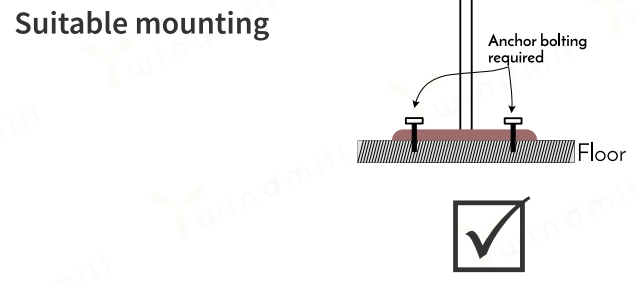

IP64
Outdoor wet rated

Customisable Sweep sizes (cm.)

140
150

Optional accessories

 4 speed remote

Customisable finish for fan motor and metal blades

 matt copper
 antique bronze
 matt pewter
 oil rubbed bronze
 matt black
 matt white (RAL 9010)

Customisable material and finish for fan blades

 wood finish metal



Riviera Mark 2 features Rain protection. So you can install the fan in open spaces and be free of mind that rain can do any harm.
Curved blades elegantly spread the cool air down as the fan whirls in silence.
All metal powder painted parts, ensures the fan stands the harsh heat, cold and damp winds.



home

	300 mm.	400 mm.
Tech specs	Power: 40 watt	73 watt
	Airflow: 1200 CFM	1800 CFM
Standard features	AC Motor	
	Fully compatible with Automation systems	

Dimensions



IP60
Indoor rated

Customisable Sweep sizes (cm.)

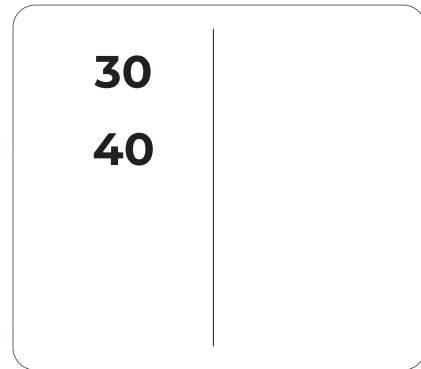

Optional accessories

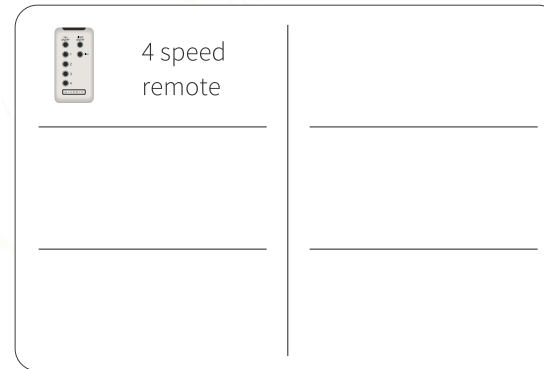

Customisable finish for fan motor and metal blades



Customisable material and finish for fan blades



wood finish metal

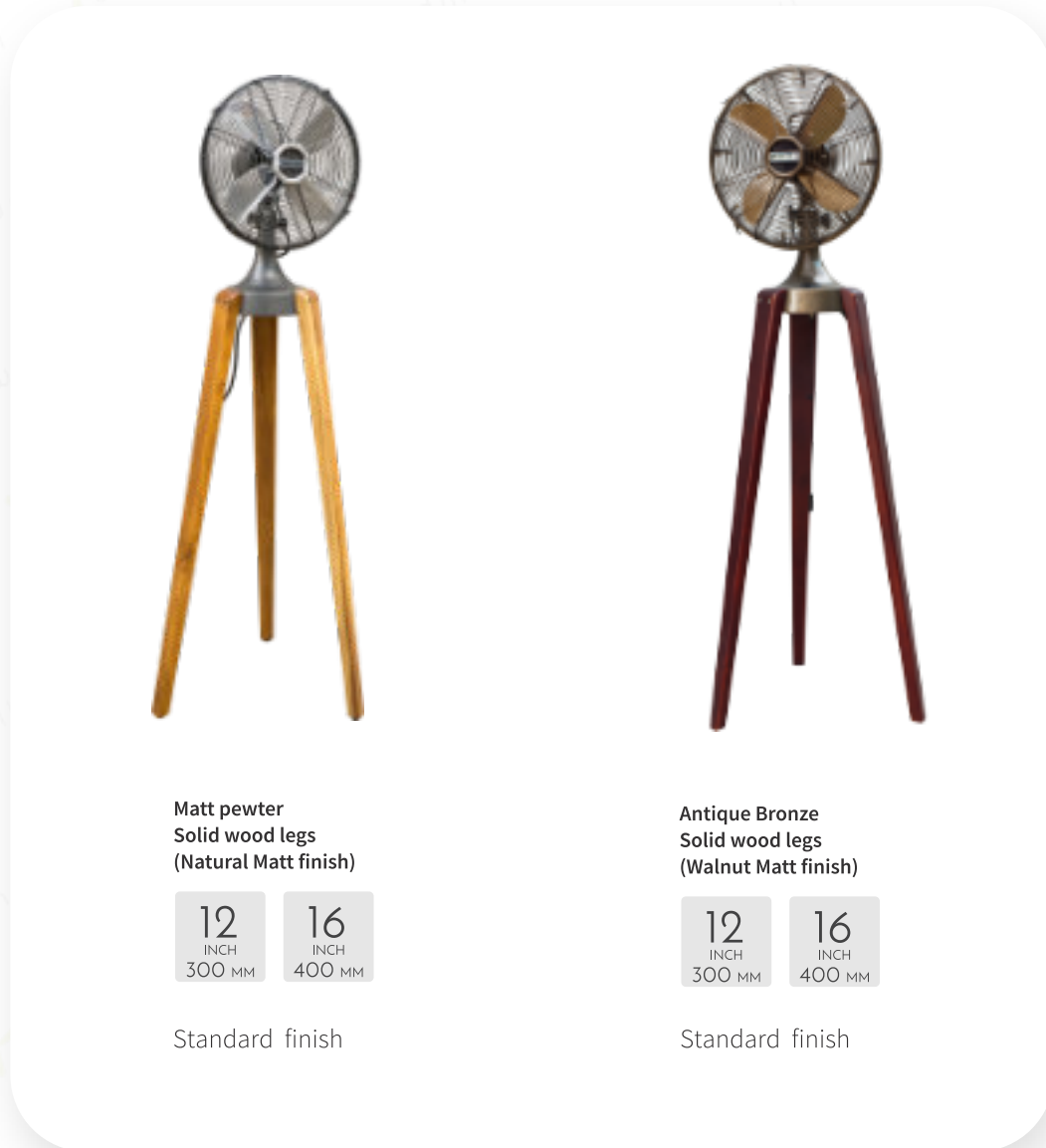

Matt pewter
Solid wood legs
(Natural Matt finish)

12 INCH
300 MM 16 INCH
400 MM

Standard finish

Antique Bronze
Solid wood legs
(Walnut Matt finish)

12 INCH
300 MM 16 INCH
400 MM

Standard finish

Handmade all metal Rugged and Durable fans; Classic TRIPOD design with hand polished Solid wood legs.

A true symbol of Luxury for your office, lounge or Study.

Oscillating design with Great air delivery and built-in 3 Speed controller.



1050 mm. 1200 mm. 1300 mm.

Tech specs	Power:	45 watt	50 watt	55 watt
	Airflow:	5500 CFM	6800 CFM	7300 CFM

Standard features	AC Motor
	Fully compatible with Automation systems

Working environment Suitable for indoor use and covered open spaces
 Suitable for covered outdoor use (select finishes)

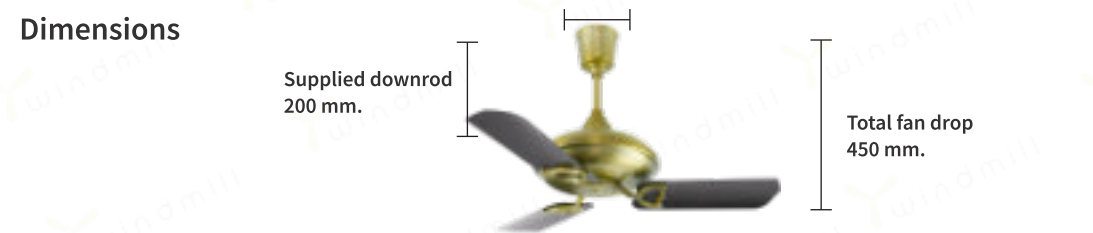
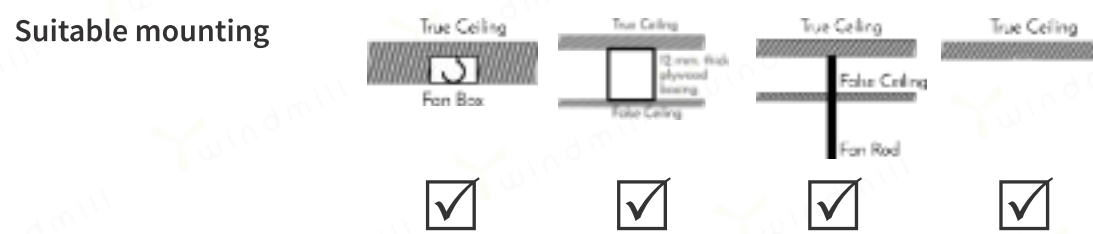

Customisable Sweep sizes (cm.)

105
120
130
140

Optional accessories

- 4 speed remote
- reverse operation
- 5 speed wall controller
- slant ceiling mount

Customisable finish for fan motor and metal blades

glossy copper	gold	matt copper	antique bronze	matt pewter	oil rubbed bronze
matt black	matt white (RAL 9010)	bright white (RAL 9003)	brushed aluminum	brushed brass	

Customisable material and finish for fan blades

solid teak wood (matt walnut)	solid teak wood (natural matt)	lamine teak wood (walnut matt)	lamine teak wood (natural matt)	beech wood (natural matt)	wood finish metal

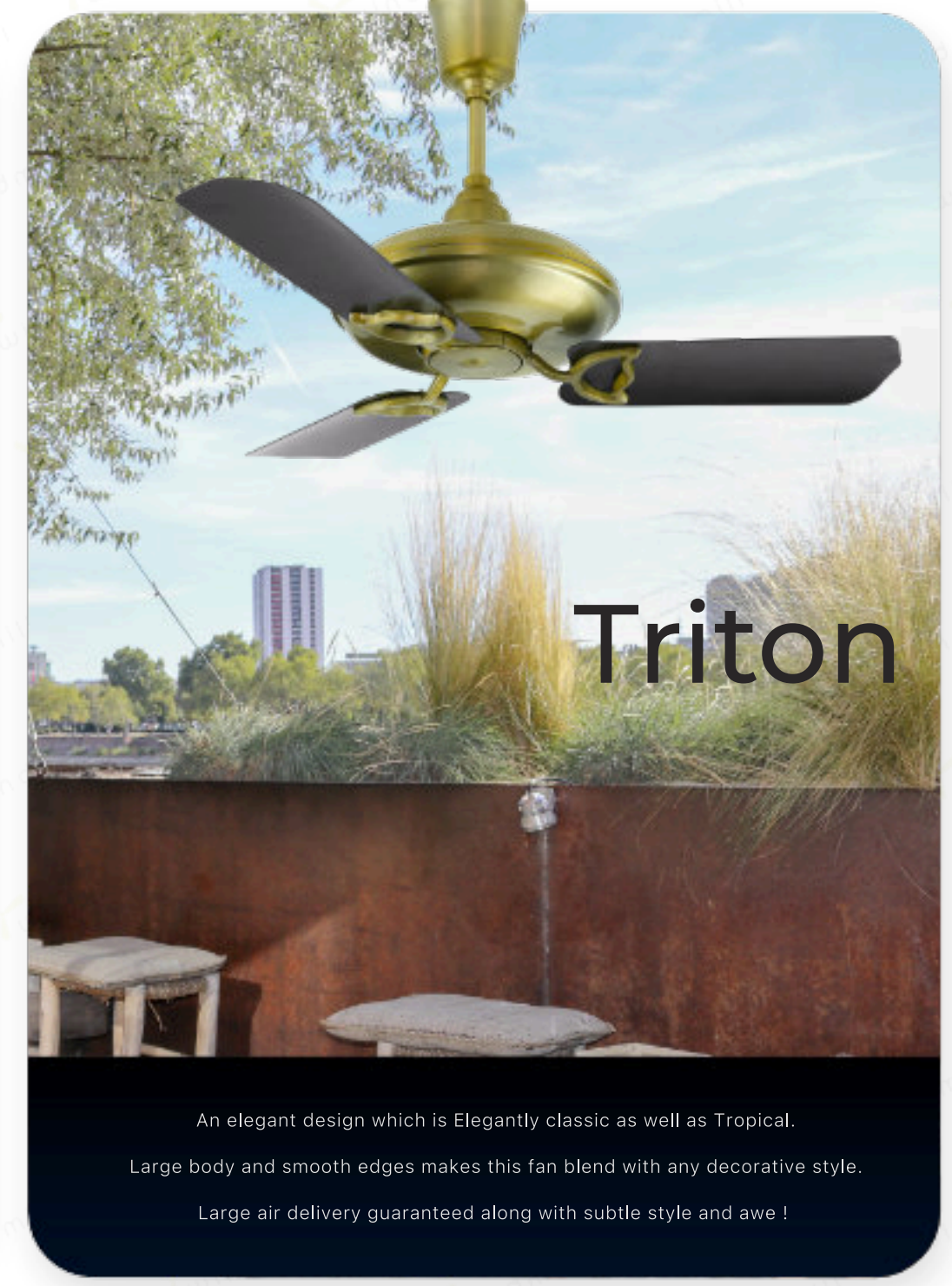
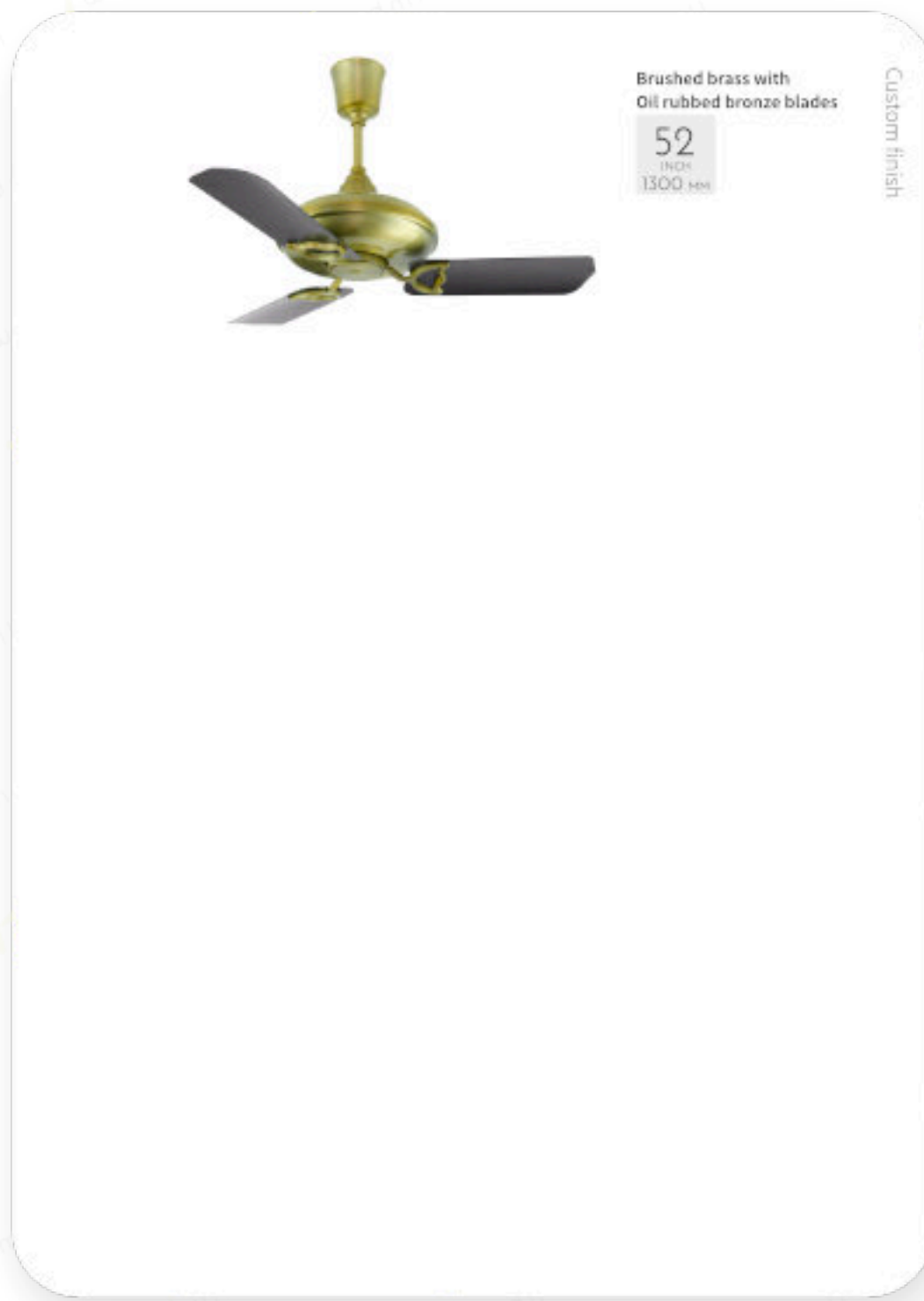

An elegant design which is Elegantly classic as well as Tropical.
 Large body and smooth edges makes this fan blend with any decorative style.
 Large air delivery guaranteed along with subtle style and awe !

1300 mm.

Tech specs
Power: 55 watt
Airflow: 7500 CFM

Standard features
AC Motor
Fully compatible with Automation systems

Working environment
Suitable for indoor use and covered open spaces
Suitable for covered outdoor use (select finishes)

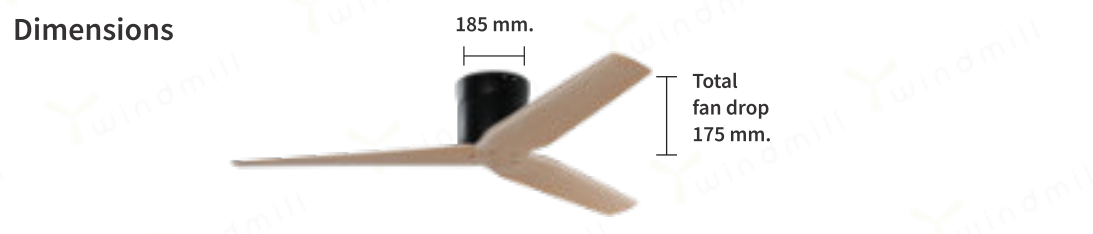
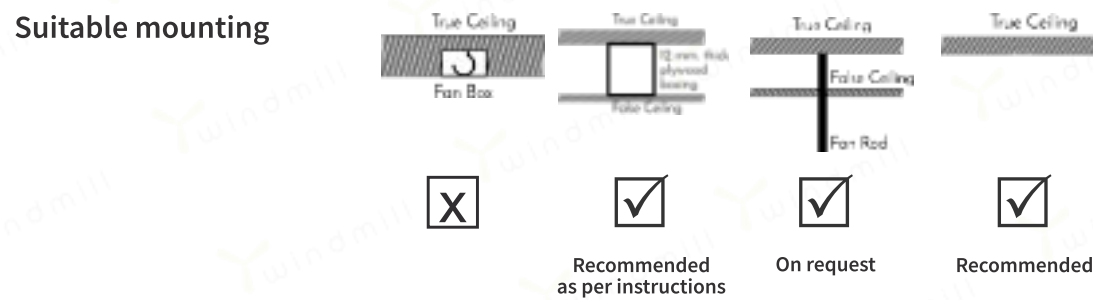

Customisable Sweep sizes (cm.)

120
130

Optional accessories

- 4 speed remote
- 5 speed wall controller

Customisable finish for fan motor and metal blades

- glossy copper
- gold
- matt copper
- antique bronze
- matt pewter
- oil rubbed bronze
- matt black
- matt white (RAL 9010)
- bright white (RAL 9003)
- brushed aluminum
- brushed brass
- matt silver

Customisable material and finish for fan blades

- beech wood (natural matt)
- birch wood (walnut matt)

- Matt Black Solid beech wood propeller (Natural Matt)**
52 INCH 1300 MM
Custom finish
- Matt Pewter Solid beech wood propeller (Natural Matt)**
52 INCH 1300 MM
Custom finish
- Antiqu Bronze Solid beech wood propeller (Natural Matt)**
52 INCH 1300 MM
Standard finish
- Matt Silver Solid beech wood propeller (Natural Matt)**
52 INCH 1300 MM
Custom finish

Velocita hugger

HUGGER (Flush Ceiling Mounting) designed to install ceiling fan for Low Height ceilings, without compromise on air delivery.

Ultra sleek, modern lines coupled with Areodynamic carved Solid beech wood propeller. Best in performance and luxury with silent Air delivery and complete compatibility with all automation systems.



HERITAGE 1910



CUSTOM ASANA

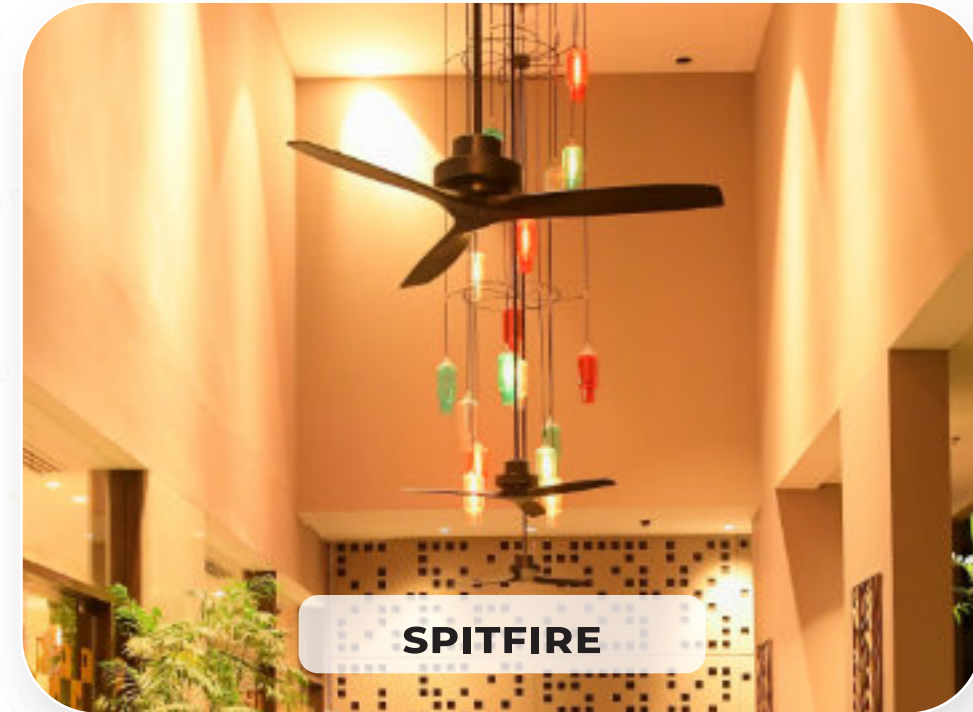

SPITFIRE



COLONIA



ASANA NEO



MODENA



INDUSTRIE

GALLERY



COLONIAL CABIN

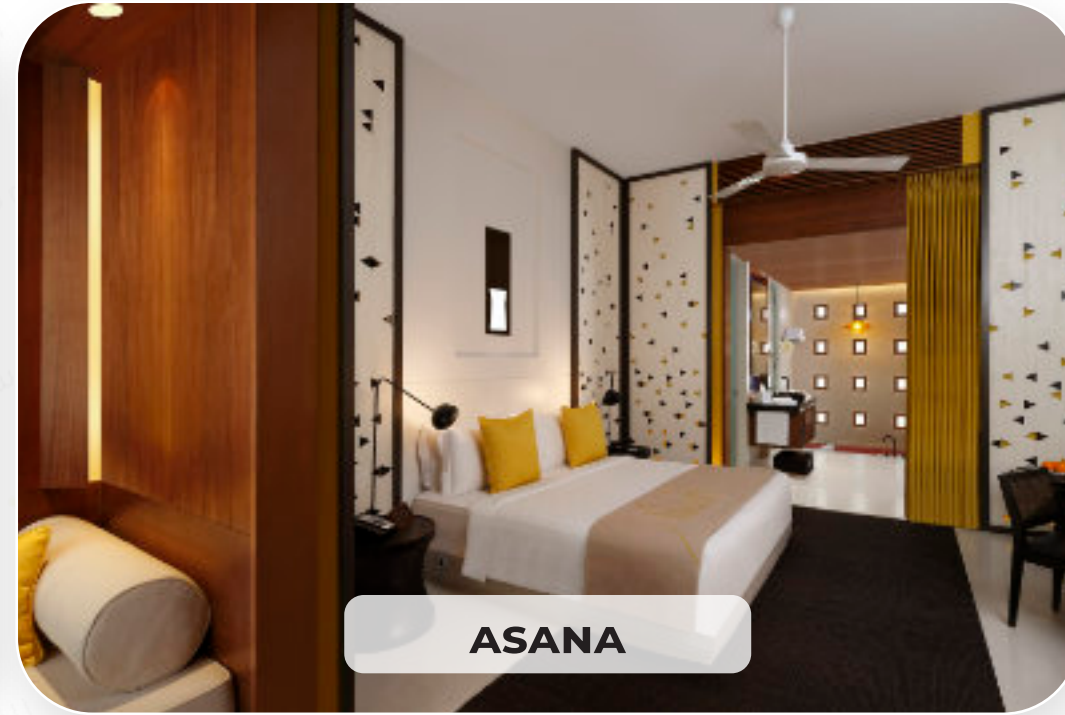

ASANA

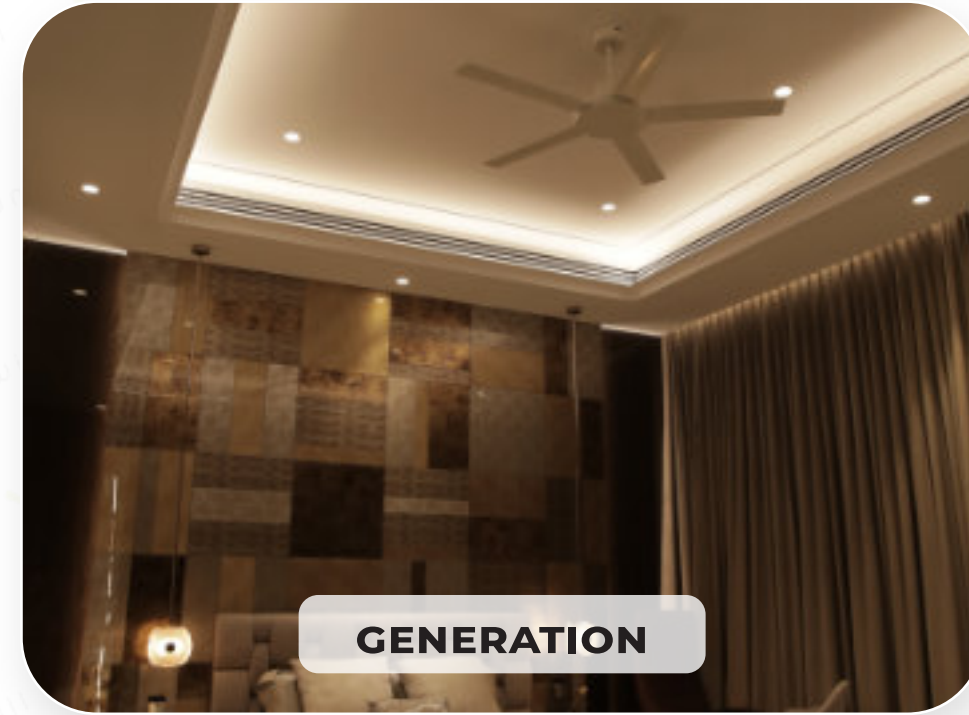

GENERATION



SCEPTRE

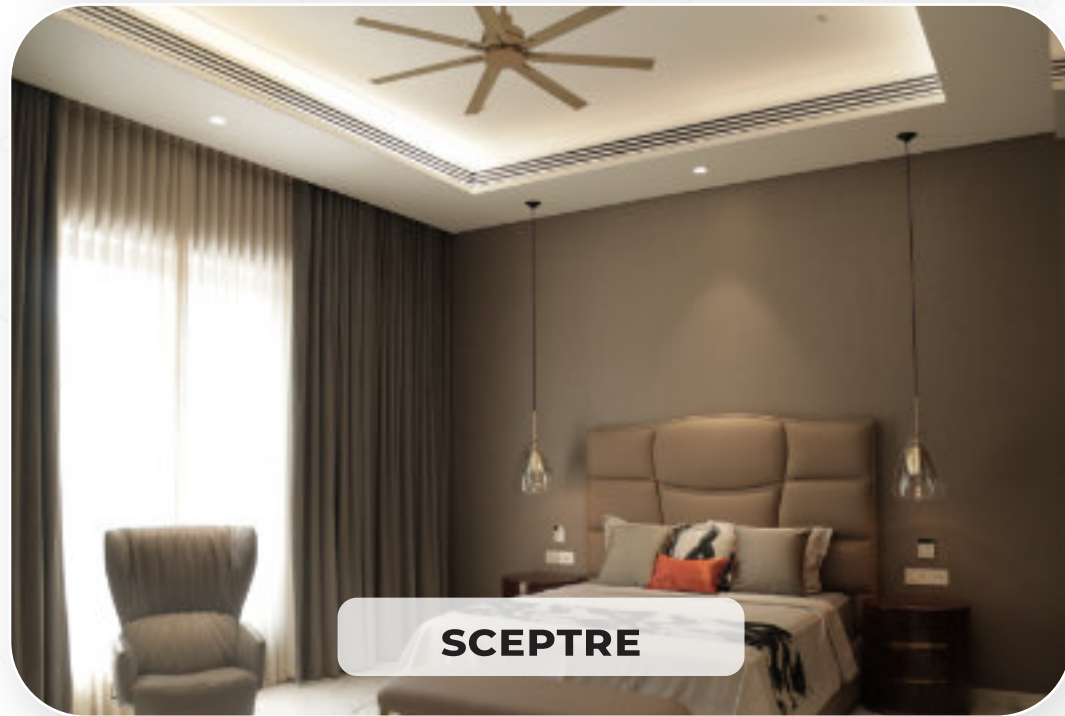

SCEPTRE



BAROLLO



ASANA HUGGER

GALLERY



AIRXONE



ASANA



MODENA



AIRXONE



COLONIA

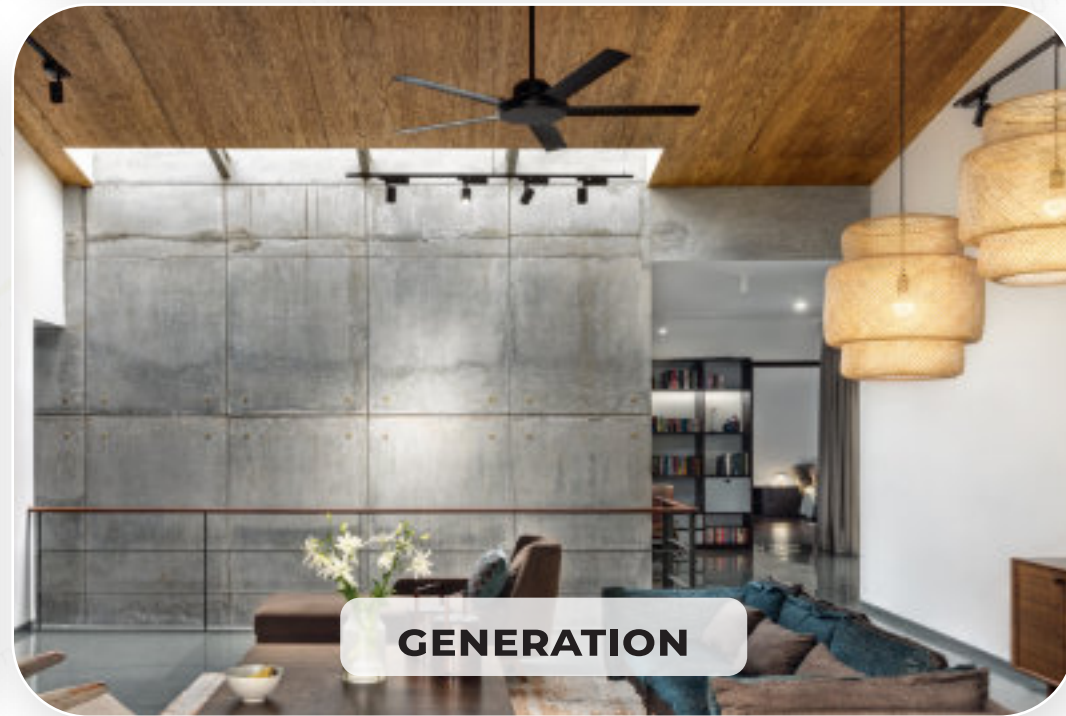

GENERATION



AMALFI

GALLERY



AIRXONE HUGGER



STEALTH



HORNET

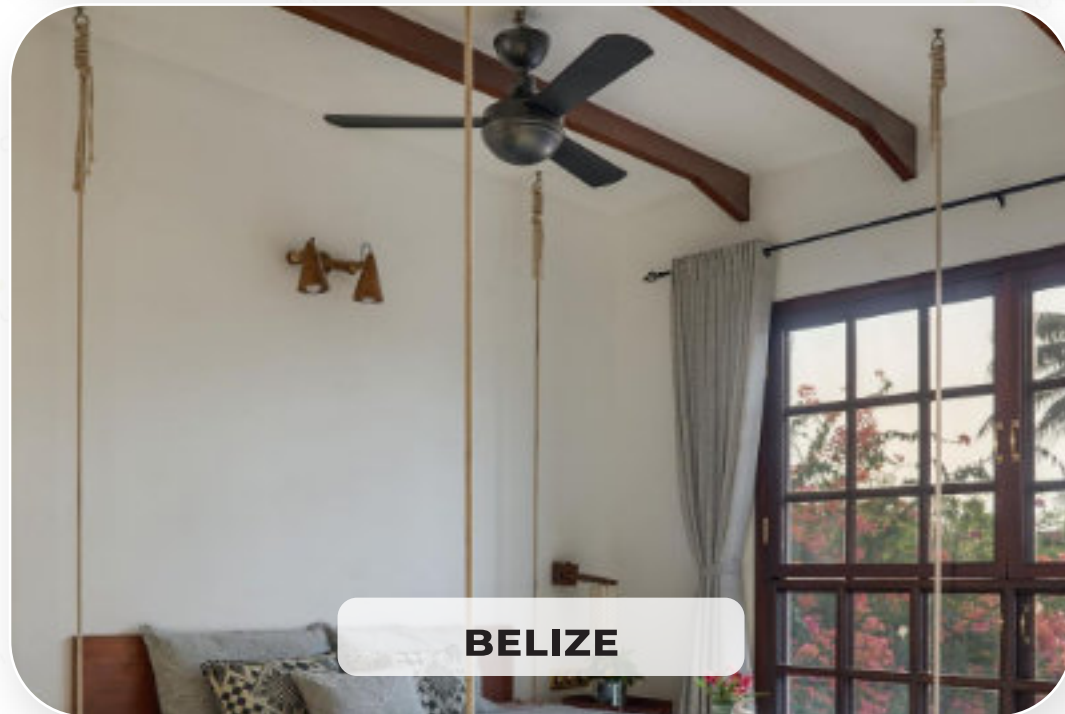

BELIZE

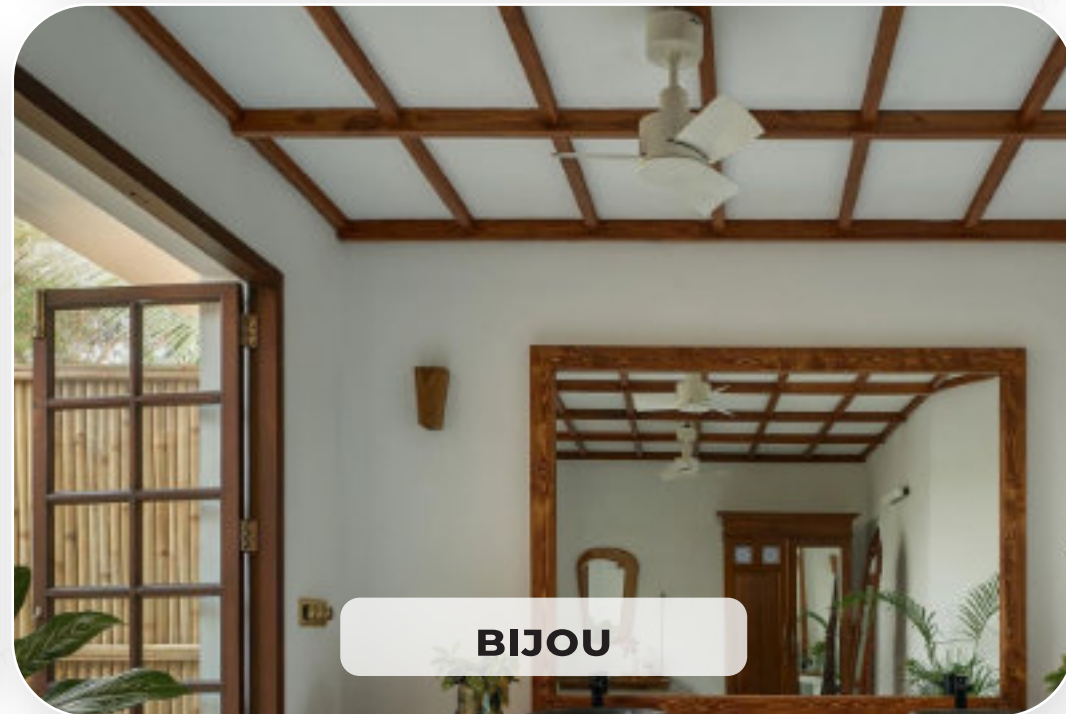

BIJOU



AIRNAUTIK



BAROLLO CEILING

home

GALLERY



MAREILLY

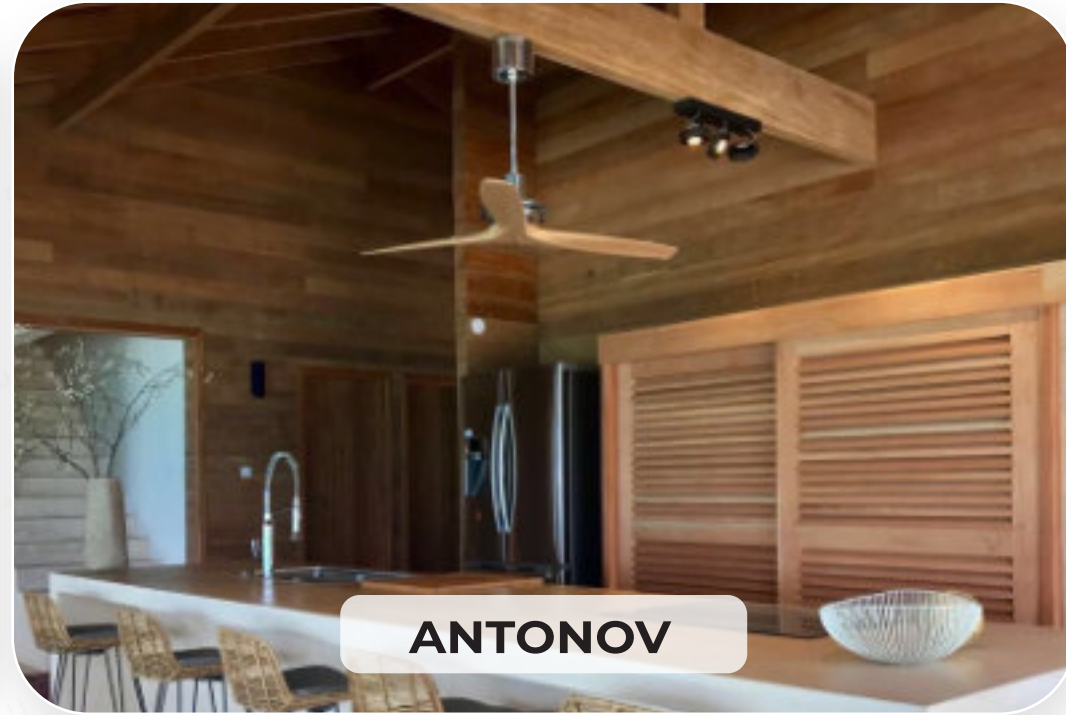

ANTONOV



AIRXONE



AMALFI



OCTOBER HUGGER



INDUSTRIE

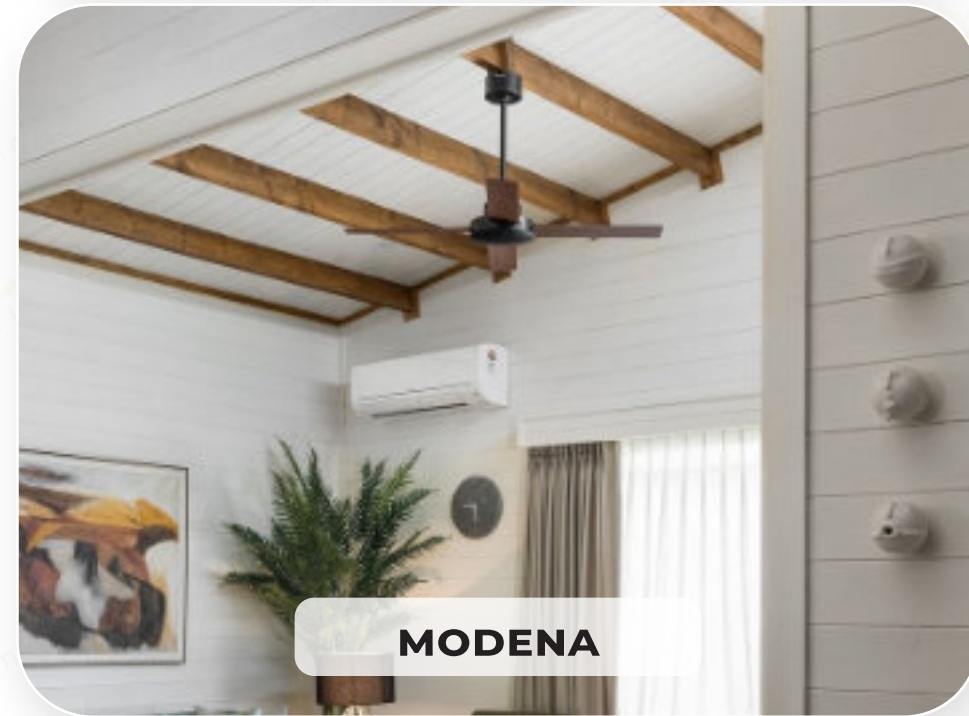

MODENA

GALLERY

OUTDOOR GRADE FAN MOTOR AND BLADE FINISH



Matt Pewter (MP)

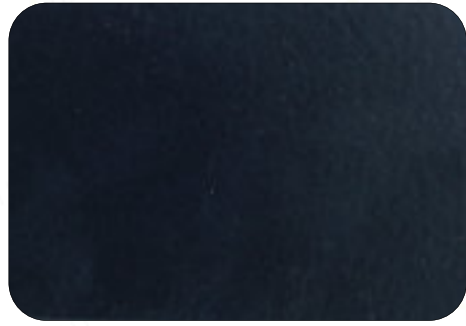

Matt Black (MB)



Matt White (MW)

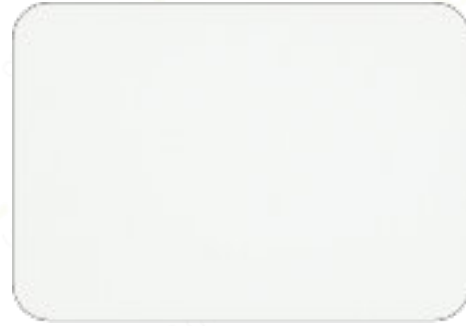

Bright White (GW)



Oil Rubbed Bronze (ORB)



Matt Copper (MC)

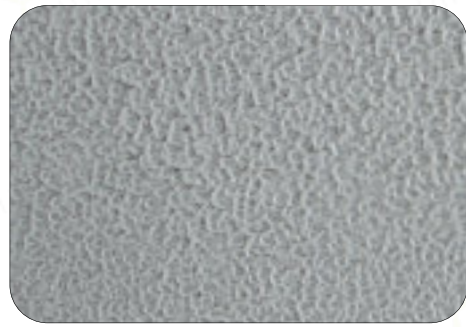

Antique White (AW)

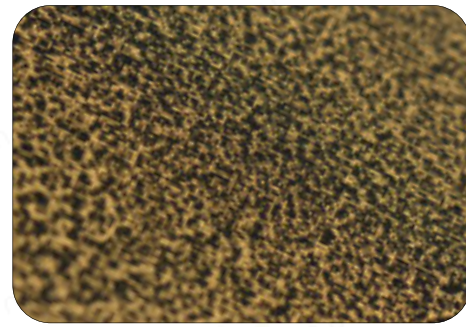

Antique Bronze (AB)



Matt Silver (MS)

OUTDOOR GRADE FAN MOTOR AND BLADE FINISH

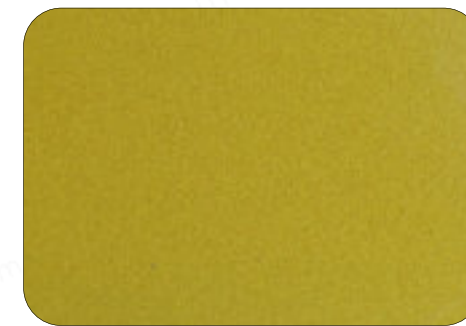

Gold (G)



Polished Aluminium (PA)



Brushed Aluminium (BA)



Glossy Copper (GC)

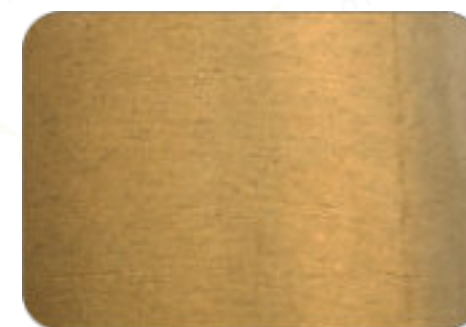

Brushed Brass (BB)

**CUSTOM
FAN
FINISHES**

INDOOR GRADE FAN BLADE MATERIAL & FINISH



Teak plywood blades (LTW-W)
Dark Matt finish



Teak plywood blades (LTW-N)
Natural Matt finish



Solid Teak wood (STW-W)
Dark Matt finish



Solid Teak wood (STW-N)
Natural Matt finish



Wood Finish metal blades (WFM)



Birch Wood propeller (BIRWP)
Dark Matt finish



Beech Wood (BW)
Natural Matt finish

OUTDOOR GRADE FAN BLADE FINISH

**CUSTOM
FAN
FINISHES**

Since 1980's these fans have been exported to Europe, United Kingdom, Australia and USA. They have gathered accolades from Designers, Architects and have earned the trust of millions of discerning clients.

We have undertaken projects with size ranging from One home to 300 home residential projects, from boutique hotels to 200 room 5 Star Spa and Resort.

No Customer is small for us; we can supply quantities as small as 2 fans to as large as container loads.

Few of our esteemed clients include the following



SANGATH



COLLABORATIVE ARCHITECTURE



Studio LAB



Arvind varuna associates



sP+a



OUR CLIENTS



asds
Aditi Sharma
Design Studio



SNA
Sidharth Narayan
Associates

Designers Circle
(Ahmedabad)

Ar. Manpreet Singh
(Delhi)

Ar. Sudeep Verma
(Delhi)

Int. Suchitra Singh
(Kanpur)

Hotel Shompen
(Chennai)

Century Builders
(Bangalore)

InHaus Design
(Hyderabad)

Nattika Beach Resort
(Kovalam)



Laxmi Machine Works **Intas Pharmaceuticals**



OUR CLIENTS



[home](#)



SHOWROOM
PARTNERS



PDF
BROCHURE



EMAIL
YOUR QUERY

WWW.WINDMILLFANS.COM

U. P. NATIONAL MANUFACTURERS LTD.

C 26/34 -B-D, SHREE DHAM COMPLEX,
RAMKATORA ROAD, VARANASI - 221002. U.P. (INDIA)