

ODULAR
FFICE FURNITURE

ÁGATA LIVING
by Virendra & Co.



The Core Competitiveness

ÁGATA LIVING
by Urendra & Co.



Office Furniture

ÁGATA LIVING
by Urendra & Co.



45/60mm LINEAR

Panel Base System

PROMOTE EFFICIENCY

Panel Base, modular office partition systems from Ergo Touch, suitable for diverse and mobile professional of today. Panel Base System is an amalgamation of aesthetics, and flexibility

- Panel thickness 45/60mm.
- Frame constructions - Aluminium.
- Easy access to power, data and voice cabling.
- Flexible and easily expandable.
- Quick and easy installation.
- Simple to re-configure
- In-built 2 wire raceways 1 is for data & voice and 1 is for power.
- Partition Panel Insertions : Fabric / Laminate / Glass / Perforated Steel
- In-built slot to hold range of accessories

designed to fit your lifestyle

At the team level, the system encourages communication between workers, organizes Office Space, facilitates frequent reconfigurations, absorbs new employees and balances individuals privacy and group dynamics.

The personal work station must be close to adjacent work station so as to facilitates spontaneous meeting or quick consultation.

It is very suitable to such situation in which the staff members need to process plans, which are of different specialty, responsible for various plans and need to have frequent meetings for discussion and decision-making.

This system shapes and organizes management structures, streamlines installation and layout, optimizes floor spaces, installation and layout, optimizes floor spaces, coordinates storage and material handling and control chaos.

This systems expresses space aesthetics for you, mingling arts with decoration, combining arts with work, offering brilliant possibilities, making practically less ordinary and uniqueness more elegant, making spaces arts more lively.



Model No.: ERG 102



AGATA LIVING
by Vrendra & Co.

Model No.: ERG 104



Model No.: ERG 103



Model No.: ERG 105

45/60mm LINEAR

Panel Base System



45/60mm LINEAR

Panel Base System



Model No.: ERG 106



Model No.: ERG 107



Model No.: ERG 110



Model No.: ERG 111



Model No.: ERG 108



Model No.: ERG 109



Model No.: ERG 112



Model No.: ERG 113





Model No.: ERG 114



Model No.: ERG 115



Model No.: ERG 118



Model No.: ERG 119



Model No.: ERG 116



Model No.: ERG 117



Model No.: ERG 120



Model No.: ERG 121



**45/60MM
CURVILINEAR**
Panel Base System

INSPIRES INNOVATION

A modular office partition system that is rugged and stylish in vogue. An ergonomics design to promote efficiency and creates an ambience that captures your corporate style.

- Panel thickness 45/60mm.
- Frame constructions - Aluminium.
- Easy access to power, data and voice cabling.
- Flexible and easily expandable.
- Quick and easy installation.
- Simple to re-configure
- In-built 2 wire raceways 1 is for data & voice and 1 is for power.
- Partition Panel Insertions : Fabric / Laminate / Glass / Perforated Steel
- In-built slot to hold range of accessories

perfection of form and function

Ergo Touch conjures a total feeling of ease, comfort and control. Every component and function has been condensed to the importance of getting the work done.

The design exhibits your individuality and character without being obtrusive. It is convincing from any perspective and adds a touch of perfection to any room.

Distinctive design elements with the wide choice of materials, and you would truly have a workspace you can call your own. It is a definite design which speaks for itself.

Intelligent space planning with design versatility combined to achieve a fluid and free flowing expression for individual workspace and team interaction.

Requirement of the times, reflection of fashion, concise, comfortable and elegant, fit to the human body, attention is put complete relaxation.



Model No.: ERG 202



Model No.: ERG 204



Model No.: ERG 203



Model No.: ERG 205

45/60MM CURVILINEAR

Panel Base System



45/60MM CURVILINEAR

Panel Base System



Model No.: ERG 206



Model No.: ERG 209



Model No.: ERG 207



Model No.: ERG 208



Model No.: ERG 210

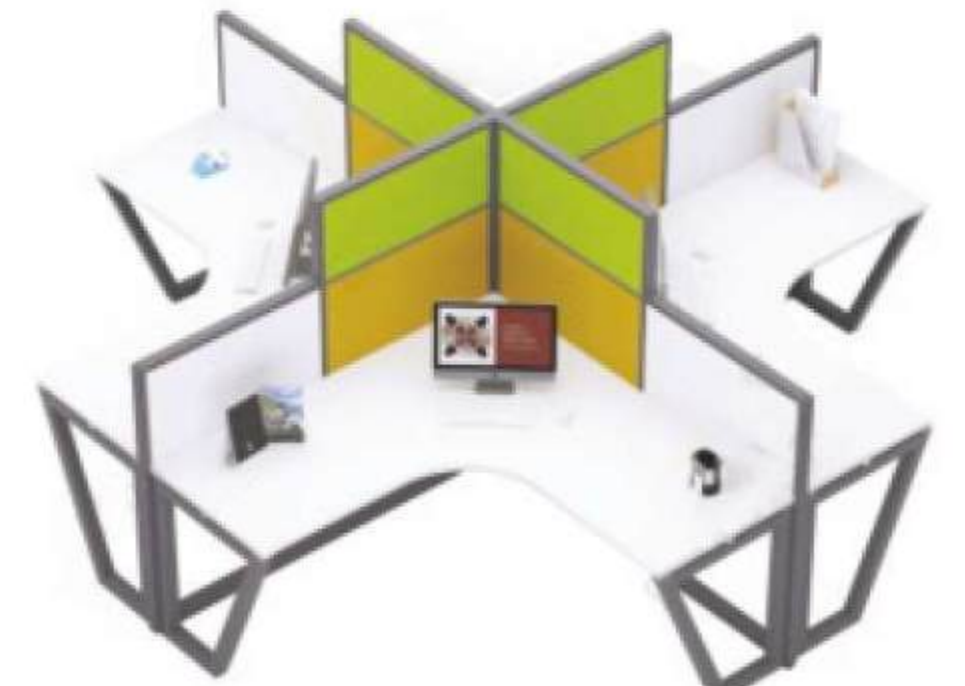

Model No.: ERG 211



45/60MM CURVILINEAR

Panel Base System



Model No.: ERG 212



Model No.: ERG 213



Model No.: ERG 216



Model No.: ERG 217



Model No.: ERG 214



Model No.: ERG 215



Model No.: ERG 218



Model No.: ERG 219



45/60MM CURVILINEAR

Panel Base System





Model No.: ERG 301

45+30/60+30 COMBO SERIES

Panel Base System

ENCOURAGES SPONTANEITLY

An extraordinary achievement in furniture. Efficacy and technology. every thing you need in an office. Especially, well suited for go-getters.

- Panel thickness 30/45/60mm.
- Frame constructions - Aluminium.
- Easy access to power, data and voice cabling.
- Flexible and easily expandable.
- Quick and easy installation.
- Simple to re-configure
- In-built wire raceways for concealed wiring.
- Partition Panel Insertions : Fabric / Laminate / Glass / Perforated Steel



Model No.: ERG 302

space for the free imagination

Ergo Touch aesthetics of refined simplicity makes a strong visual statement about your corporate image and assists in creating visual consistency throughout the office. Ergo Touch makes a difference in the way your office looks, functions and performs.

Feathered with wonderful design which introduces the language of science, it enriches your job with more efficiency and more excellent.

Embrace the modern work culture, in which a team work environment must not restrict the process of collaboration. This through is what prompted the creation of Ergo Touch.

Simple and unadorned design creates the atmospheres of steady and modest, makes you experience the dignity and exclusivity in wide vision.



Model No.: ERG 303



Model No.: ERG 305



Model No.: ERG 304



Model No.: ERG 306

180+30/60+30 COMBO SERIES

Panel Base System



Model No.: ERG 307



Model No.: ERG 308



Model No.: ERG 309



Model No.: ERG 310



45+30/60+30 COMBO SERIES

Panel Base System



Model No.: ERG 311



Model No.: ERG 312



Model No.: ERG 313



Model No.: ERG 314





Model No.: ERG 401



Model No.: ERG 402

LOW HEIGHT CUBICLES

ENHANCES APTNESS

Elegance shaped into desks. This is Ergo Touch. A perfect blend of flexibility, suitability and comfort.

- Panel thickness 30mm /45mm /60mm.
- Frame/bracket/legs - Aluminium.
- Possibility to fit power, data and voice cabling.
- Flexibility to be easily expandable.
- Demountable easy installation.
- Simple to re-configure
- Inbuilt 2 wire raceways 1 is for data & voice and 1 is for power.
- Option Panel Insertions : Fabric / Laminate / Glass / Perforated Steel
- In-built slot to hold range of accessories

designed for enhanced efficiency

Modern office structures are often designed to support teams. These require a flexibility that encourages free-flowing collaboration and collaboration. To serve these team goals and individual members, Ergo Touch can be configured to balance independent work to provide open areas for teamwork and shared resources and to create workstations personalized for each user.

Ergo Touch maintains excellence in aesthetic design and durability with unyielding material quality. Its premium wooden finish reflects the simplicity and elegant look, with proven value for investment.

Ergo Touch condenses the diversity of spatial function on a single plane. The platform is the office. But it is more than a piece of office furniture. It's a management tool for cultural change.



Model No.: ERG 403



Model No.: ERG 404

LOW HEIGHT

Cubicles



LOW HEIGHT

Cubicles



Model No.: ERG 405



Model No.: ERG 406



Model No.: ERG 409



Model No.: ERG 407



Model No.: ERG 408



Model No.: ERG 410



Model No.: ERG 411



Open Desking

DESIGNED FOR OPENNESS

Share poetry woven around slim panels and elegantly designed under structures a style which is a timeless classic of modular furniture

Understructures we have :

- Square frame leg
- Geometric frame legs
- Triangular legs
- Square legs
- Aluminium die casted legs
- Metallic legs

a strategic resource for your office design

Today organizational structures are often based on project teams. These teams require a work setting that encourages free flowing communication and collaboration. To serve both team goals and individual members our open desking systems can be configured to balance interaction and independent work, to provide open areas for team work and share resources, and to create workstation personalized for each user.

Open desking systems marks the excellence in aesthetic design and durability with unyielding metal frames reflects the superiority and elegant look, with proven value for investment.

Open desking system condenses a diversity of spatial functions on a single plane : The platform is the office. But it is more than a piece of office furniture . It is a management tool for culture change.



Model No: ERG 502



Model No.: ERG 504



Model No.: ERG 503



Model No.: ERG 505



Model No.: ERG 506



Model No.: ERG 508



Model No.: ERG 507



Model No.: ERG 509



Model No.: ERG 510



Model No.: ERG 511



Model No.: ERG 512

**OPEN
DESKING**



Model No.: ERG 513



Model No.: ERG 514



Model No.: ERG 515



Model No.: ERG 516



**OPEN
DESKING**



Model No.: ERG 517



Model No.: ERG 518



Model No.: ERG 519



Model No.: ERG 520

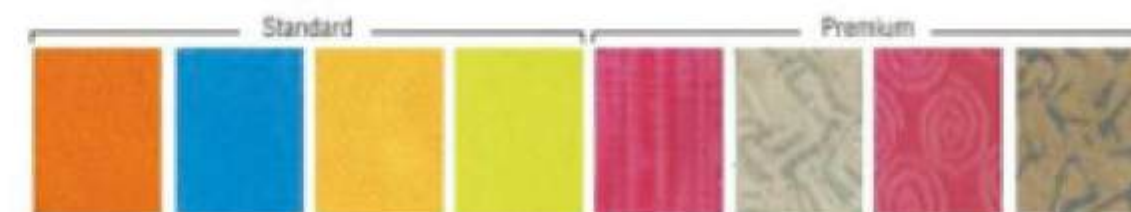



Model No.: ERG 521



Model No.: ERG 522



Model No.: ERG 523



Model No.: ERG 524



Model No.: ERG 525



Model No.: ERG 526



Model No.: ERG 527



Model No.: ERG 528





Model No.: ERG 529



Model No.: ERG 530



Model No.: ERG 531



Model No.: ERG 532



Model No.: ERG 533



Model No.: ERG 534



Model No.: ERG 535



Model No.: ERG 536





Model No.: ERG 537



Model No.: ERG 538



Model No.: ERG 539



Model No.: ERG 540



Model No.: ERG 541



Model No.: ERG 542



Model No.: ERG 543



Model No.: ERG 544





Model No.: ERG 545



Model No.: ERG 546



Model No.: ERG 547



Model No.: ERG 548



Model No.: ERG 549



Model No.: ERG 550



Model No.: ERG 551



Model No.: ERG 552



OPEN
DESKING



Model No.: ERG 553



Model No.: ERG 554



Model No.: ERG 557



Model No.: ERG 558



Model No.: ERG 555



Model No.: ERG 556



Model No.: ERG 559



Model No.: ERG 560

OPEN
DESKING





Model No.: ERG 561



Model No.: ERG 562



Model No.: ERG 565



Model No.: ERG 566



Model No.: ERG 563



Model No.: ERG 564



Model No.: ERG 567



Model No.: ERG 568



OPEN
DESKING



Model No.: ERG 569



Model No.: ERG 570



Model No.: ERG 571



Model No.: ERG 572



OPEN
DESKING



Model No.: ERG 573



Model No.: ERG 574



Model No.: ERG 575



Model No.: ERG 576





Model No.: ERG 577



Model No.: ERG 578



Model No.: ERG 579



Model No.: ERG 580



Model No.: ERG 581



Model No.: ERG 582



Model No.: ERG 583



Model No.: ERG 584





Model No.: ERG 585



Model No.: ERG 586



Model No.: ERG 587



Model No.: ERG 588



Model No.: ERG 589



Model No.: ERG 590



Model No.: ERG 591



Model No.: ERG 592



Model No.: ERG 593



Model No.: ERG 594



Model No.: ERG 595



Model No.: ERG 596



Executive Desk Standard

It is luxurious and practical, it is noble and illustrious. All is based on the clever collision of traditional craftsmanship and aesthetic concept of the modern noble.

- Artistically crafted, designer executive range best stress Midirizuel Management.
- ~~unusually~~ customizable range designed for great space saving and ~~extra~~ installations for open offices.
- ~~unusually~~ streamlined design of rectangular master table with fixed or movable drawers.
- ~~Material~~ 25mm and 18mm pre-laminated particle/MDF boards

classic and traditional

The expression of new classicism, the sample of combining tradition and the modern, practical and elegant.

All metal tender and glass embellishment, matched with leather writing mat, bringing you comforts and convenience.

Utilize and ingenious combination of round, kidney and rectangular shapes to form absolutely novel designs. Not only unrestrained and generous, but also features the practical flexibility, inspiring you and giving you infinity power.



Model No.: ERG 602



Model No.: ERG 604



Model No.: ERG 603



Model No.: ERG 605

EXECUTIVE DESK

Premium



EXECUTIVE DESK

Premium



Model No.: ERG 606



Model No.: ERG 607



Model No.: ERG 608



Model No.: ERG 609



Model No.: ERG 610



Model No.: ERG 611



Model No.: ERG 612



Model No.: ERG 613



Model No.: ERG 614



Model No.: ERG 615



ModelNo.: ERG 616



Model No.: ERG 617





Model No.: ERG 618



Model No.: ERG 620



Model No.: ERG 619



Model No.: ERG 621



Model No.: ERG 622



AGATA LIVING
by Urendra & Co.

Model No : ERG 624



Model No. ERG 623



Model No.: ERG 625



Model No.: ERG 626



Model No.: ERG 627

EXECUTIVE DESK

With Metal Understructure



Model No.: ERG 628



Model No.: ERG 629



Model No.: ERG 630



Model No.: ERG 631



EXECUTIVE DESK

With Metal Understructure



Model No.: ERG 632



Model No.: ERG 633



Model No.: ERG 634



Model No.: ERG 635



EXECUTIVE DESK

With Metal Understructure



Model No.: ERG 636



Model No.: ERG 637



Model No.: ERG 638



Model No.: ERG 639



EXECUTIVE DESK

With Metal Understructure



Model No.: ERG 640



Model No.: ERG 641



Model No.: ERG 642



Model No.: ERG 643



EXECUTIVE DESK

With Metal Understructure



EXECUTIVE DESK

With Metal Understructure



Model No.: ERG 644



Model No.: ERG 645



Model No.: ERG 648



Model No.: ERG 649



Model No.: ERG 646



Model No.: ERG 647



Model No.: ERG 650



Model No.: ERG 651



EXECUTIVE DESK

With Metal Understructure



EXECUTIVE DESK

With Metal Understructure



Model No.: ERG 652



Model No.: ERG 653



Model No.: ERG 656



Model No.: ERG 657



Model No.: ERG 654



Model No.: ERG 655



Model No.: ERG 658



Model No.: ERG 659



Executive Desk Premium

It is luxurious and practical, it is noble and illustrious
All is based on the clever collision of traditional craftsmanship and aesthetic concept of the modern noble

- Artistically crated, designer executive range best suited for Top level Management.
- individually customizable range designed for great space saving and efficient workstations for open offices.
- Simply streamlined design of rectangular master tables with large capacity side and back credenza or semi round discussion tops.
- Made of 62mm/36mm/25mm and 18mm pre-laminated particle/MDF boards

magnificent and elegant

Magnificent and elegant appearance, simple and smooth shape, exquisite and refined work, dignified and graceful colours - it is a piece of artwork and it can bring you more perfect enjoyment.

The unique designs of the executives desks shows a kind of board vision of managerial elites attending to numerous affairs everyday and they will be proud of the executive desks

The harmonious co-existence of elegance and fashion, the free demonstration of exquisite and luxury, superb nobility is represented from different angles of space, the thought provoking bearing of top material is there, grandly expressing trendy contents.

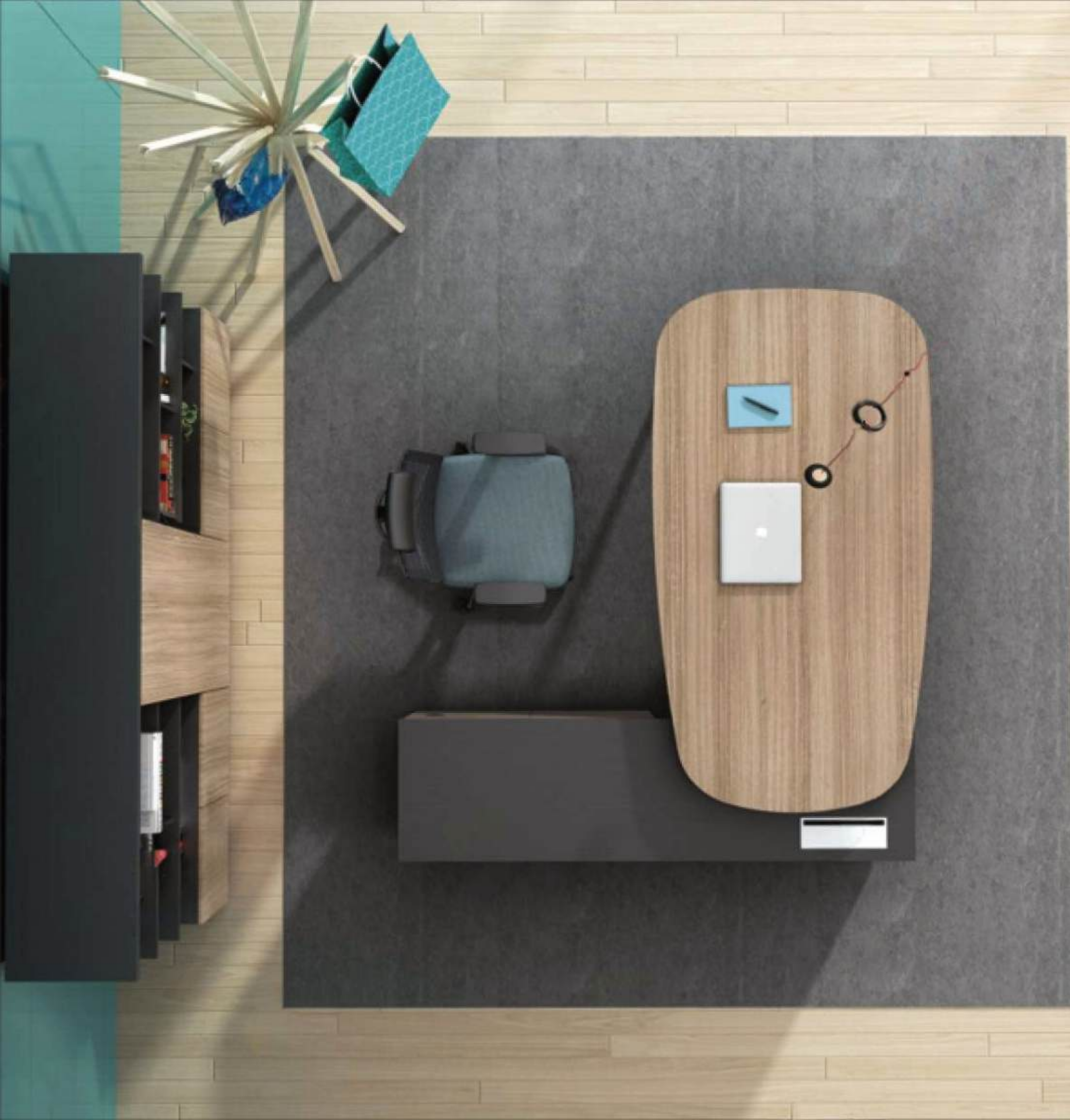



Model No.: ERG 701



Model No.: ERG 702



Model No.: ERG 703



Model No.: ERG 704



Model No.: ERG 705



Model No.: ERG 706



Model No.: ERG 707



Model No.: ERG 709



Model No.: ERG 708



Model No.: ERG 710



Model No.: ERG 711



Model No.: ERG 713



Model No.: ERG 712



Model No.: ERG 714



Model No.: ERG 715



Model No.: ERG 717



Model No.: ERG 716



Model No.: ERG 718

EXECUTIVE DESK

Premium



Model No.: ERG 719



Model No.: ERG 720



Model No.: ERG 721



Model No.: ERG 722



EXECUTIVE DESK

Premium



Model No.: ERG 723



Model No.: ERG 724



Model No.: ERG 725



Model No.: ERG 726



EXECUTIVE DESK

Premium



Model No.: ERG 727



Model No.: ERG 728



Model No.: ERG 729



Model No.: ERG 730



EXECUTIVE DESK

Premium



Model No.: ERG 731



Model No.: ERG 732



Model No.: ERG 733



Model No.: ERG 734



Storage Systems

REFLECTS INTEGRITY OF YOUR BUSINESS

Comfort and productivity seems to go hand in hand. So take care of business secrets now, and indulge yourself with a nap later.

Place for everything and everything in its place

Ergonomics storage units add flexibility to the system, making it possible to achieve unlimited work configurations.

Ergo Touch offers lots of storage options to keep your files and supplies organized.

Maximize volume storage space with our range of storage units including cabinets, drawers units and shelving for office or industrial workplace.

Sturdily constructed modular storage cabinets have capability to hold a host of components in several drawers. These are furnished with safety lock on the door for the complete safety of these components.

Our design objectives is to offer a range that suits your particular needs and tastes, is easy and comfortable to use, and reflects the integrity of your business.

Storage units are available in edge banded & post form lacquered versions with adjustable shelves. Drawers are available with roller and telescopic slide options.

Storages are made using best combination of design and state-of-the-art technology. Resulting in an extensive range of style and sizes for every individual's storage needs.



To Keep Your Surroundings Organized





ÁGATA LIVING
by Vrendra & Co.

STORAGE

System



STORAGE

System



Model No.: ERG 801



Model No.: ERG 802



Model No.: ERG 803



Model No.: ERG 807



Model No.: ERG 808



Model No.: ERG 809



Model No.: ERG 804



Model No.: ERG 805



Model No.: ERG 806



Model No.: ERG 810



Model No.: ERG 811



Model No.: ERG 812



STORAGE

System



Model No.: ERG 813



Model No.: ERG 814



Model No.: ERG 815



Model No.: ERG 816



Model No.: ERG 817



Model No.: ERG 818

Features



Softly corner



High adjustable



Handleless handle



Water repellent

STORAGE

System



Model No.: ERG 819



Model No.: ERG 820



Model No.: ERG 821



Model No.: ERG 822



Model No.: ERG 823



Model No.: ERG 824



Model No.: ERG 825

Options



Wood



Glass



Double doors



Double doors

STORAGE

System



STORAGE

System



Model No.: ERG 826



Model No.: ERG 827



Model No.: ERG 830



Model No.: ERG 831



Model No.: ERG 828



Model No.: ERG 829



Model No.: ERG 832



Model No.: ERG 833



Model No.: ERG 834



Model No.: ERG 835



Model No.: ERG 838



Model No.: ERG 839



Model No.: ERG 836



Model No.: ERG 837



Model No.: ERG 840



Model No.: ERG 841



IRON SHELF
WOOD BOXES
PLANTS
BOOKS
FRAMES



Model No.: ERG 842

ÁGATA LIVING
by Virendra & Co.



Model No.: ERG 843

Drawer Pedestal

- Optional design for selection.
- 5th anti-tilt caster fitted at the file drawers of mobile pedestal.
- Central lock supplied as standard.
- All channels finished in black and ivory as standard.
- Various colour options.
- Handle : C-Shape and I-Shape

best for keeping surroundings

We have a range of drawer unit in loads of different style and with plenty of different features and functions. Some are made of metal and other have a variety of wood finish.

Our drawer units can provide a useful solutions to a range of issues in the office, many of our units have castors, so you can move them around to where you need them / whenever you need them.

Our drawer units comes in a range of heights. Some are tall and free standing, and others will fit snugly in place underneath your desktop.

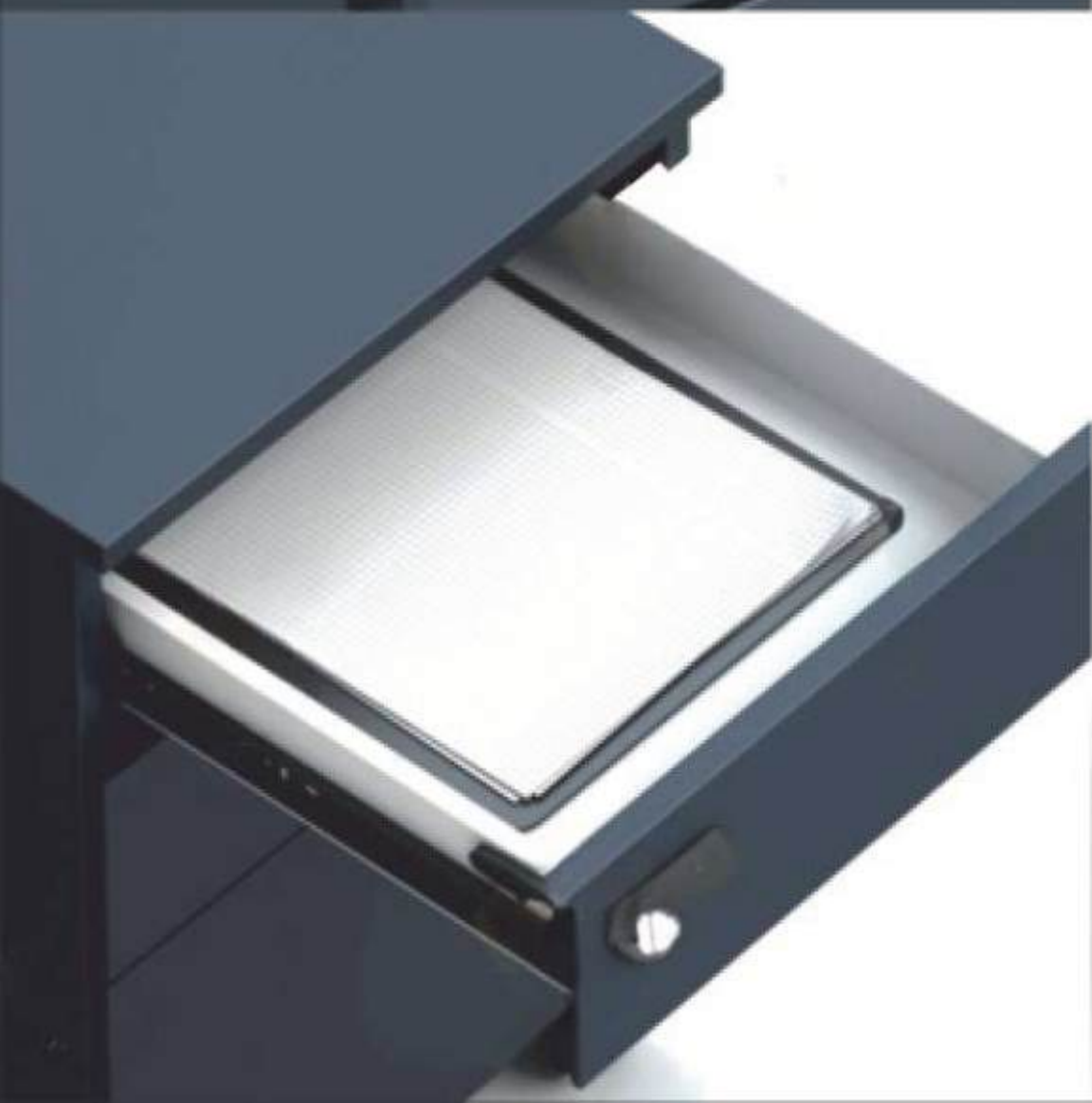

Model No.: ERG 901

DRAWER

Pedestal



Model No.: ERG 902



Model No.: ERG 903



Model No.: ERG 904



Model No.: ERG 905



Model No.: ERG 906



Model No.: ERG 907



DRAWER

Pedestal



Model No.: ERG 908



Model No.: ERG 909



Model No.: ERG 910



Model No.: ERG 911



Model No.: ERG 912



Model No.: ERG 913





Meeting Rooms Board Room Solutions

**SMOOTH, NATURAL
AND PROFOUND**
Smooth, natural and profound, it
demonstrate individual colours and
relaxing and co-operative atmosphere
as well as the vigorous office
environment. The elite talk freely to
exchange inspiration gracefully.

- Top thickness 36/48/62mm
- Table height customized by our designers or fully customized designs
- Digital clock reference.
- Multiple units equipped with rich features that support power, data source, HDMI.
- Various combination and styles for face to face or group discussion, important presentations or any other work scenario.
- Wire riser : Laminated/Metal
- Access Flap : Laminated with Brush / Aluminium Anodized with Brush / Metal Powder Coated with Brush / PVDF with Finger groove.

elegant designs for elegant people

Round Conference Table is of Elegant and grand shape to match with the environment. It lets the thinking extend, supplies a room of warmth, wisdom and magnificence.

Magnificent design is of extra-ordinary style, unique lines and profile, flexible and healthy taste to further represent the leadership style that is so outstanding.

Conference Table features exquisite designed and demonstrate charm of the times and fill the room with vitality. It not only stresses design but also stresses practical functions.





Model No.: ERG 1003



ÁGATA LIVING
by Virendra & Co.

Model No.: ERG 1004



Model No.: ERG 1005



Model No.: ERG 1006



Model No.: ERG 1007



Model No.: ERG 1009



Model No.: ERG 1008



Model No.: ERG 1010



Model No.: ERG 1011



Model No.: ERG 1012



Model No.: ERG 1017



Model No.: ERG 1018



Model No.: ERG 1013



Model No.: ERG 1014



Model No.: ERG 1019



Model No.: ERG 1020



Model No.: ERG 1015



Model No.: ERG 1016



Model No.: ERG 1021



Model No.: ERG 1022





Model No.: ERG 1023



Model No.: ERG 1025



Model No.: ERG 1024



Model No.: ERG 1026





Model No.: ERG 1028



Model No.: ERG 1029



Model No.: ERG 1031



Model No.: ERG 1030



Model No.: ERG 1032



Model No.: ERG 1033



Model No.: ERG 1034



Model No.: ERG 1039



Model No.: ERG 1040



Model No.: ERG 1035



Model No.: ERG 1036



Model No.: ERG 1041



Model No.: ERG 1042



Model No.: ERG 1037



Model No.: ERG 1038



Model No.: ERG 1043



Model No.: ERG 1044



Reception

Sourcing from best design concepts, it is dignified, refined and meet in shape, flexible in combination, capable of matching with interior decoration with different key colour to create brand new modern office environment.

- Desks are either customized by our designer or fully custom designs as per your preference
- With or without pullout Keyboard Tray
- Provision for CPU
- Provision for personal belongings and stationary
- provision for drawers storages

Face of workstation

First Impression of a modern office is 'Reception Table'. Made with the of providing easy but unobtrusive contact with visitors. These tables also have sleek wire management and mobile storage space.

- Individualized taste
- Every space and every combination
- Every detail can represent different taste and different culture feeling
- Unconsciously revealed grace embellishes the comfortable atmosphere of offices.

It integrates elegance with practicality with enterprise concepts, adding new vitality to enterprise.

Model No.: ERG 2001



Model No.: ERG 2002



Model No. ERG 2004



Model No.: ERG 2003



Model No. ERG 2005

RECEPTION



Model No.: ERG 2006



Model No.: ERG 2007



Model No.: ERG 2008



Model No.: ERG 2009



Model No.: ERG 2010



Model No.: ERG 2011



Model No.: ERG 2012



Model No.: ERG 2013



RECEPTION



Training Tables

ENCOURAGE INTERACTION

Ergo Touch Training Tables allow for easy setup, re-configuration and storage. A quick and simple one step release enables the top to flip and lock.

Our selection of stylish training tables sets up easily, stores efficiently, and supports technology conveniently.

Ergonomics design, aiming to improve your health and create a comfortable life for you.

Contemporary style and ultimate attitude combined with ample breathing space makes this system a sophisticated choice.

shape the way you teach and love

Featuring value and versatility at its best, Ergo Touch adjustable training tables extend the benefits of electronically - modulated sit - stand work surfaces to everyone.

The ability to move must be simple and accessible to ensure desired outcomes. Ergo Touch folding tables are the ideal solution.

The Ergo Touch training table has a classic design that never goes out of style, its simple contemporary lines make it appropriate for any setting and its extensive product offering allow for customization of design and function.



Model No.: ERG 3001



Model No.: ERG 3003

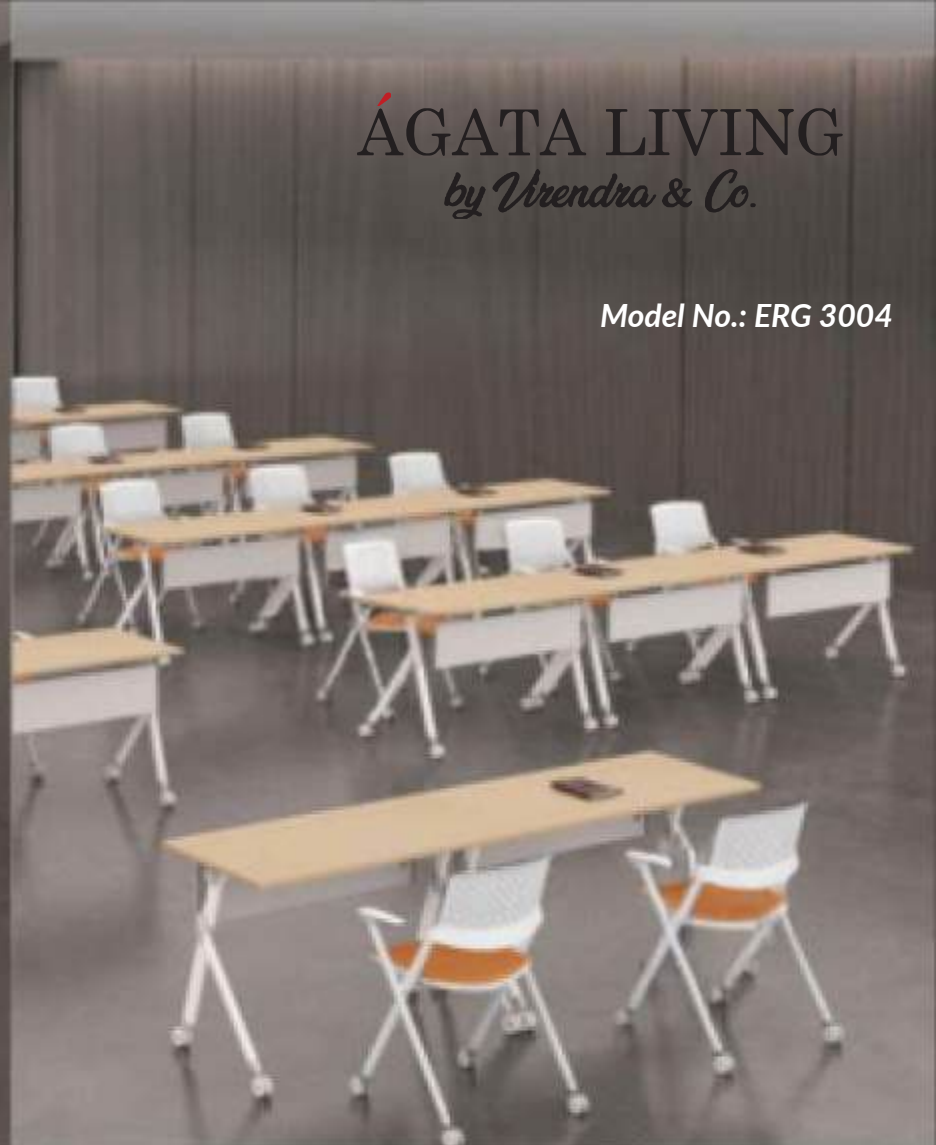

AGATA LIVING
by Virendra & Co.

Model No.: ERG 3004



Model No.: ERG 3002



Model No.: ERG 3005



Model No.: ERG 3006

TRAINING

Tables



TRAINING

Tables



Model No.: ERG 3007



Model No.: ERG 3008



Model No.: ERG 3005



Model No.: ERG 3010



Model No.: ERG 3011



Model No.: ERG 3012



Model No.: ERG 3013



Model No.: ERG 3014



HEIGHT ADJUSTABLE TABLES

- Easy to operate, smooth to lift
- High quality rugged steel
- Soft start / stop technology
- No jerking & no jolting
- colour : white only

It's simple alternate between standing and sitting positions with ERGO TOUCH's height adjustable table, equipped with a convenient control panel, an LED display and 4 memor presets. Your employee can adjust the table to the height they are most comfortable with, achieving a level of health, comfort and productivity that you will have to experience to believe.

start standing right away

Instead, stand for your health
It's said that office workers spends
6-9 hours of each workday sitting.
With this level of inactivity on the chair,
a whole host of serious problems can
not be far behind.

Available in single / double motor
Stages 2 / 3 / 4
Minimum height 660 mm
Maximum height 1310 mm
Height & width varies model to model

Model No.: ERG 4001



Model No.: ERG 4002



HEIGHT ADJUSTABLE TABLES



Model No.: ERG 4003



Model No.: ERG 4004



Model No.: ERG 4005



Model No.: ERG 4006



Model No.: ERG 4007



Model No.: ERG 4008

CAFETERIA FURNITURE

- Desks are either customized by our designer or fully custom designs as per your preference
- Top Choice : Pre-Lamination or Mica painted on commercial Ply Board.
- Top Thickness : 18mm - 50mm
- Top Profile : Edge band & Post Form
- Base : Mild Steel or Stainless Steel



Model No.: ERG 5001



Model No.: ERG 5002



Model No.: ERG 5003



Model No.: ERG 5004



Model No.: ERG 5005



Model No.: ERG 5006



Model No.: ERG 5007



CAFETERIA

Furniture



Model No.: ERG 5008



Model No.: ERG 5009



Model No.: ERG 5010



Model No.: ERG 5011



Model No.: ERG 5012



Model No.: ERG 5013



Model No.: ERG 5014



Model No.: ERG 5015



Model No.: ERG 5016



Model No.: ERG 5017



Model No.: ERG 5018



Model No.: ERG 5019





Model No.: ERG 5020



Model No.: ERG 5022



Model No.: ERG 5023



Model No.: ERG 5021



Model No.: ERG 5024



Model No.: ERG 5025

WOODEN LOCKERS

- locker units with shelves inside
- SS finish/PVC recessed handles
- Door with cam / kunda / combination lock
- Sophisticated screw less design for easy assembly
- Premium quality self closing hinges for smooth shutter movement
- Name card holder for each drawer
- Central locking system with chrome plated heavy duty lock
- Screw less design for easy assembling of locker
- Compact Knock Down carton for more storage

Model No. ERG 6001

WOODEN Lockers



Model No.: ERG 6002



Model No.: ERG 6003



Model No.: ERG 6004



Model No.: ERG 6005



Model No.: ERG 6006



Model No.: ERG 6007



Model No.: ERG 6008



Model No.: ERG 6009



Model No.: ERG 6011



Model No.: ERG 6010



Model No.: ERG 6012

Model No.: ERG 6013



METAL STORAGE

- High quality CRCA Steel
- Polyester powder coated
- Door with chrome plated cam lock with handle
- Sophisticated screw less design for easy assembly
- Premium quality ball bearing slides for smooth drawer/shutter movement
- Name card holder for each drawer
- Central locking system with chrome plated heavy duty lock
- Screw less design for easy assembling of drawer
- Compact Knock Down carton for more storage



Model No.: ERG 7001



Model No.: ERG 7002



Model No.: ERG 7003



Model No.: ERG 7004



Model No.: ERG 7005



Model No.: ERG 7006



Model No.: ERG 7007



Model No.: ERG 7008



METAL Storage



Model No.: ERG 7009



Model No.: ERG 7010



Model No.: ERG 7011



Model No.: ERG 7012



Model No.: ERG 7013



Model No.: ERG 7014



Model No.: ERG 7015



Model No.: ERG 7016



Model No.: ERG 7017



Model No.: ERG 7018

METAL
Storage



METAL
Storage

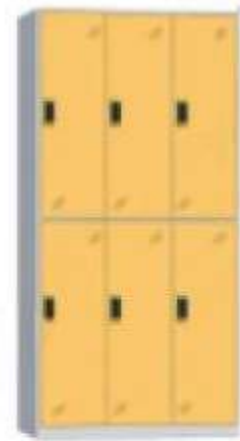

Model No.: ERG 7019



Model No.: ERG 7020

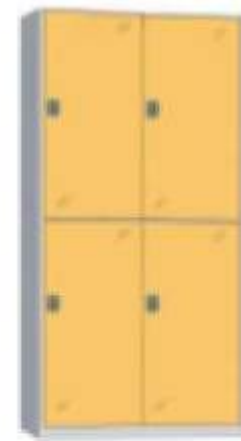

Model No.: ERG 7021



Model No.: ERG 7022

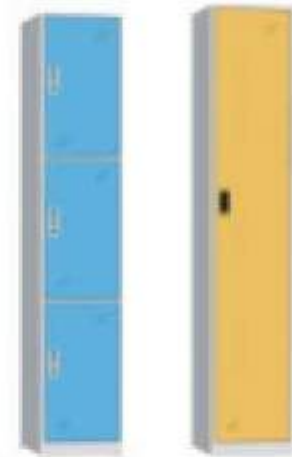

Model No.: ERG 7023
Model No.: ERG 7024



Model No.: ERG 7025



Model No.: ERG 7026



Model No.: ERG 7027



Model No.: ERG 7028



Model No.: ERG 7029



Model No.: ERG 7035



Model No.: ERG 7036



Model No.: ERG 7037



Model No.: ERG 7038



Model No.: ERG 7039



Model No.: ERG 7030



Model No.: ERG 7031



Model No.: ERG 7032



Model No.: ERG 7033



Model No.: ERG 7034



Model No.: ERG 7040



Model No.: ERG 7041



Model No.: ERG 7042



Model No.: ERG 7043



Model No.: ERG 7044



Model No.: ERG 7045



Model No.: ERG 7046



Model No.: ERG 7047



Model No.: ERG 7048



Model No.: ERG 7049

HOSTEL SERIES

Beds



Model No.: ERG 8001



Model No.: ERG 8002



Model No.: ERG 8003



Model No.: ERG 8004



Model No.: ERG 8005



Model No.: ERG 8006



Model No.: ERG 8007



Model No.: ERG 8008

STORAGE

Racks & Compactors



Model No.: ERG 8009



Model No.: ERG 8010



Model No.: ERG 8011



Model No.: ERG 8012



Model No.: ERG 8013



Model No.: ERG 8014

**HOSTEL
FURNITURE**



Model No.: ERG 8015



Model No.: ERG 8017



Model No.: ERG 8016



Model No.: ERG 8018



SCHOOL SERIES

Desks



SCHOOL SERIES

Desks



Model No.: ERG 8019



Holes in reinforcing glass strength

Bearing 150KGS

Effectively protect painting and table surface



Model No.: ERG 8020



Model No.: ERG 8021



Model No.: ERG 8022



Model No.: ERG 8023



Model No.: ERG 8024



Model No.: ERG 8025



Model No.: ERG 8026



Model No.: ERG 8027



Model No.: ERG 8028

CENTER & CORNER TABLE

Ergo Touch center and corner table series reflects the design philosophy of form following function prevalent in modernism. Our designs represent the ideals of cutting excess, practicality and an absence of decoration.



Model No.: ERG 8029



Model No.: ERG 8030

Model No.: ERG 8031



CENTER & CORNER Table



Model No.: ERG 8032



Model No.: ERG 8033



Model No.: ERG 8034



Model No.: ERG 8035



Model No.: ERG 8036



Model No.: ERG 8037



Model No.: ERG 8038



Model No.: ERG 8040



Model No.: ERG 8039



CENTER & CORNER

Table



Model No.: ERG 8041



Model No.: ERG 8042



Model No.: ERG 8043



Model No.: ERG 8044



Model No.: ERG 8045



Model No.: ERG 8046



Model No.: ERG 8047



Model No.: ERG 8048



Model No.: ERG 8049



Model No.: ERG 8050



Model No.: ERG 8051



Model No.: ERG 8052



Model No.: ERG 8053



Model No.: ERG 8054



CENTER & CORNER

Table



Model No.: ERG 8055



Model No.: ERG 8056



Model No.: ERG 8057



Model No.: ERG 8058



Model No.: ERG 8059



Model No.: ERG 8060



Model No.: ERG 8061



Model No.: ERG 8062



Model No.: ERG 8063



Model No.: ERG 8064



FURNITURE ACCESSORIES

PROMOTE EFFICIENCY
 - Perfect for individual workstations & meeting rooms
 - Smarter & Stronger
 - Space saving
 - Concealed cable management
 - Increasing comfort
 - Reduces Eye, Back & Neck strain

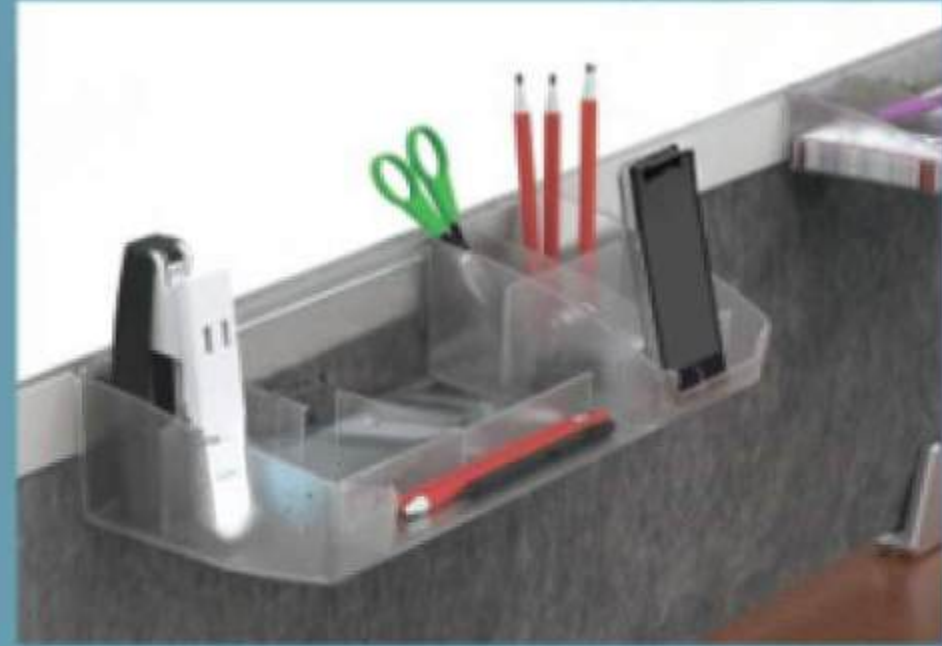

Model No.: ERG 9002



Model No.: ERG 9003



Model No.: ERG 9004



Model No.: ERG 9005



Model No.: ERG 9006



Model No.: ERG 9007



Model No.: ERG 9008



Model No.: ERG 9009



Model No.: ERG 9010



Model No. ERG 9011



Model No. ERG 9012



Model No.: ERG 9013



Model No.: ERG 9014



Model No.: ERG 9015



Model No.: ERG 9016



Model No.: ERG 9017



Model No.: ERG 9018



Model No.: ERG 9019 (A/B/C)



Model No.: ERG 9020



Model No.: ERG 9021

Model No.: ERG 9019 (A/B/C)



Model No.: ERG 9022



Model No.: ERG 9023



Model No.: ERG 9024



Model No.: ERG 9025



Model No.: ERG 9026



Model No.: ERG 9027



Model No.: ERG 9028



Model No. ERG 9029



Model No. ERG 9030



Model No.: ERG 9031



Model No.: ERG 9032



Model No.: ERG 9033



Model No.: ERG 9034

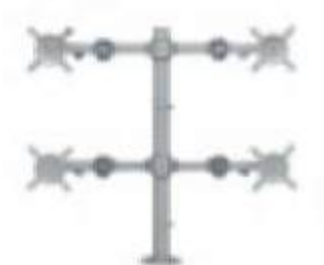

Model No.: ERG 9035

FURNITURE ACCESSORIES



Supporting Foot
Model No.: ERG 9036



Modesty Brackets
Model No.: ERG 9037

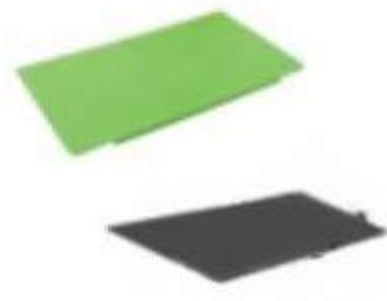
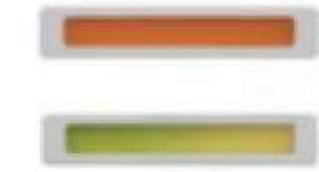

Table Mats
Model No.: ERG 9038



Ventilation Grills
Model No.: ERG 9039



HANDEL OPTIONS

Model No.: ERG 9040



Model No.: ERG 9041



Model No. ERG 9042

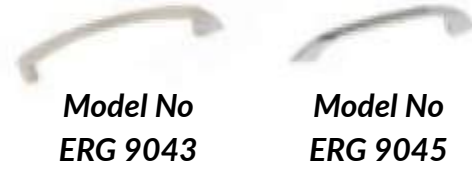

Model No ERG 9043



Model No ERG 9044

Model No ERG 9045



4 Digit Combination Lock
Model No.: ERG 9046

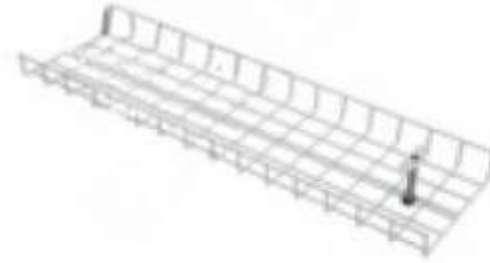

Wire Carrier
Model No.: ERG 9047



METAL PERFORATIONS

Model No.: ERG 9048



CABLE RISERS

Model No.: ERG 9049/50



GLASS SCREEN HOLDERS

Model No.: ERG 9051/52/53/54



HANGING HOLDERS

Model No.: ERG 9055/56/57/58/59/60/61/62



Pin Board-with or without frame
Model No.: ERG 9063



White Board-with or without frame
Model No.: ERG 9064



Half pinup/half white marker
Model No.: ERG 9065



Glass marker
Model No.: ERG 9066



20 mm th. aluminum frame screen
Model No.: ERG 9067

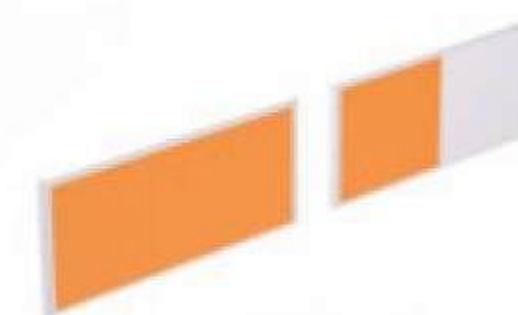

30 mm th. aluminum frame screen
Model No.: ERG 9068

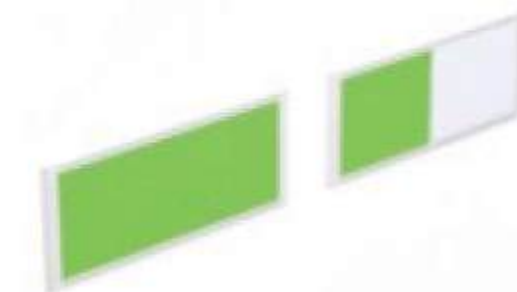

32 mm th. aluminum frame screen
Model No.: ERG 9069



8 mm lacquered glass screen
Model No.: ERG 9070



12 mm thick fabric screen
Model No.: ERG 9071



8 mm thick acrylic screen
Model No.: ERG 9072



12 mm thick acoustic screen
Model No.: ERG 9073



8 mm lacquered magnetic glass screen
Model No.: ERG 9074

PRODUCT SPECIFICATIONS

- Panel Choices
- Work Top Profiles
- Joinery
- Partition Panel Dimensions

Panel Combinations



45+30mm

60+30mm

60+60mm
45+45mm

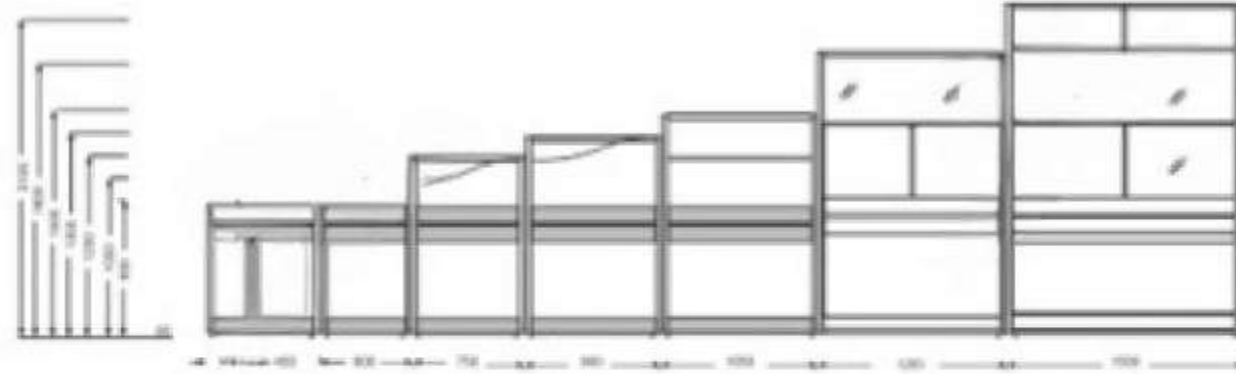

CHOICE OF PANELS



WIRE MANAGEMENT

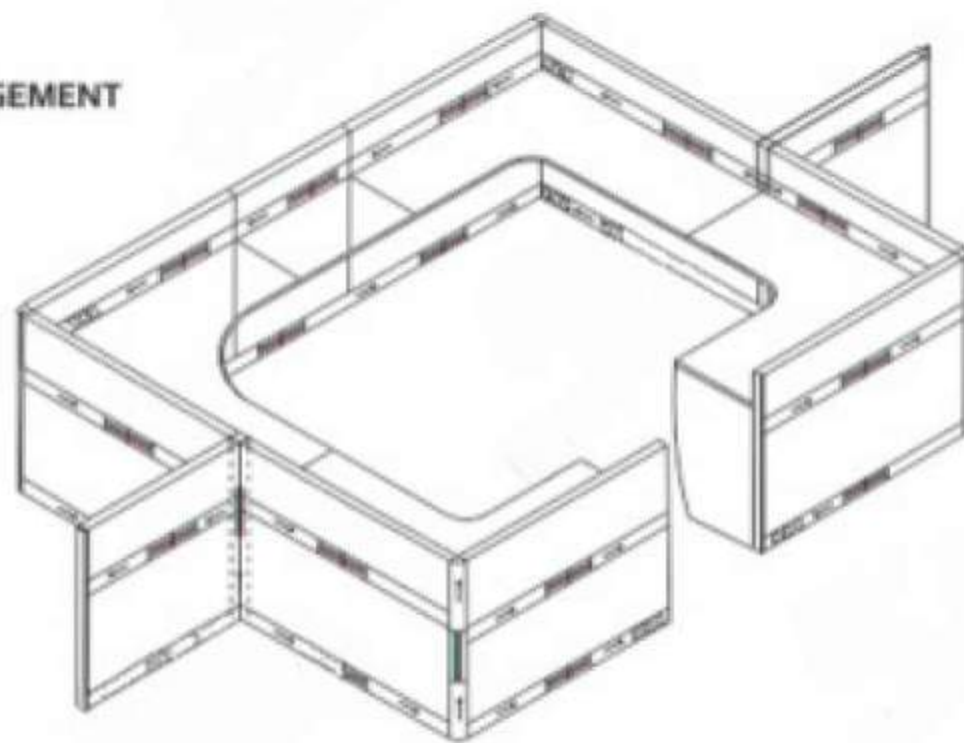

Vertical & Horizontal Wiring

All models support vertical & horizontal high capacity wiring system, ranging from 2200mm-6000mm, it can hold 36-50 network/electrical wires of 5mm thickness, which ensures a great wiring solution. All raceway systems are made of aluminium extruded sections in a snapfit formation, giving humanistic and careful design, terminating the inconvenience while installing and maintaining it. Panel based partitions also extends flexibility to flow wiring through panels vertically, giving access for wiring boards at any location. Besides one raceway provided at front, bottom of partition level, horizontal raceway can also be installed over or under worktop surfaces. The enough safe distance between the two avoids their interference.

PRODUCT Specifications



Line Management



Product Decomposition Diagram



UNDERSTRUCTURE

Legs



SQUARE (40x40/50x50)

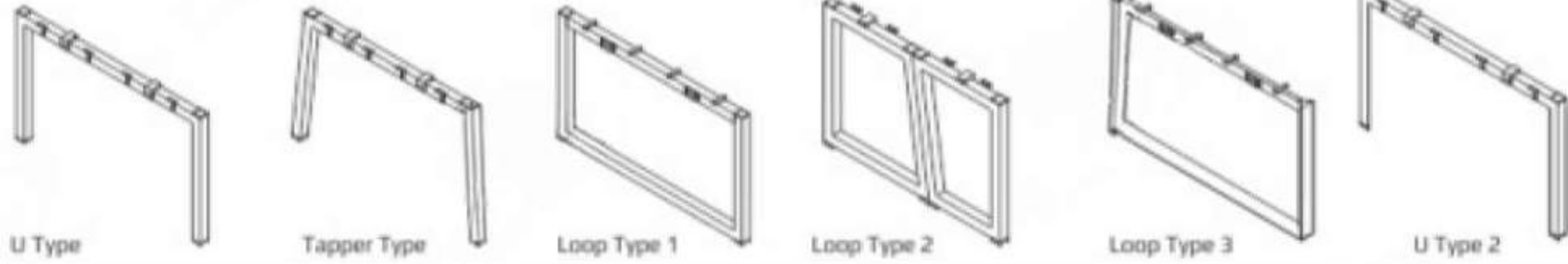

U Type Tapper Type Loop Type 1 Loop Type 2 Loop Type 3 U Type 2

RECTA (60x30/80x40)

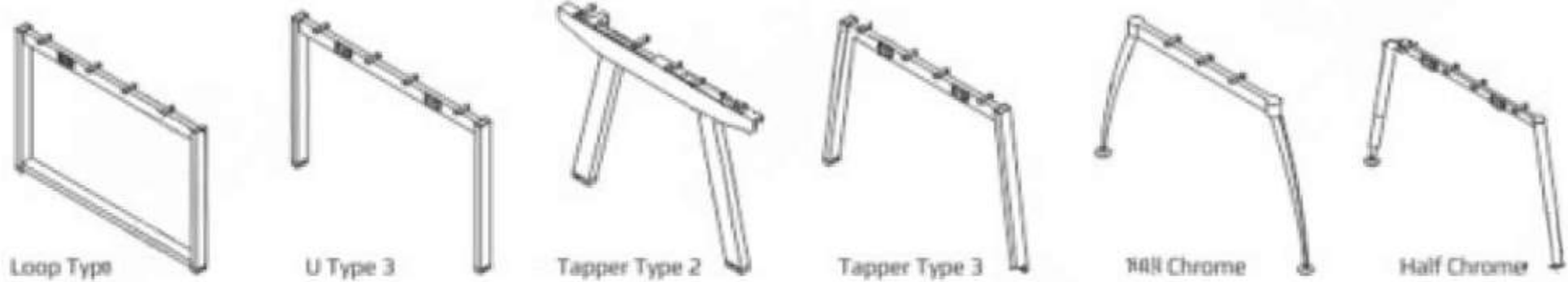

Loop Type U Type 3 Tapper Type 2 Tapper Type 3 Full Chrome Half Chrome

IMPORTED LEGS



COLOURAYS LEO SPARK EQUICE I-SHAPE



750X380mm Stainless Steel 380X330mm 450x450mm Stainless Steel 750X380mm Powder Coated 380X380mm 450x450mm Powder Coated 750X380mm 500x500mm Stainless Steel 380X380mm 450x450mm Stainless Steel 450/550 Dia MS Chrome 450/550 Dia SS Brush Finish

CONCEPTS

Clusters



LINEAR : IN LINE - NON SHARING LIMIN

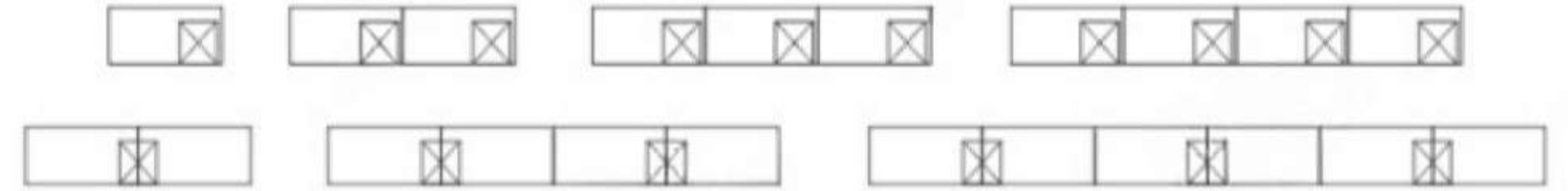

ELUFT ØIK DK TO BACK - SHARING

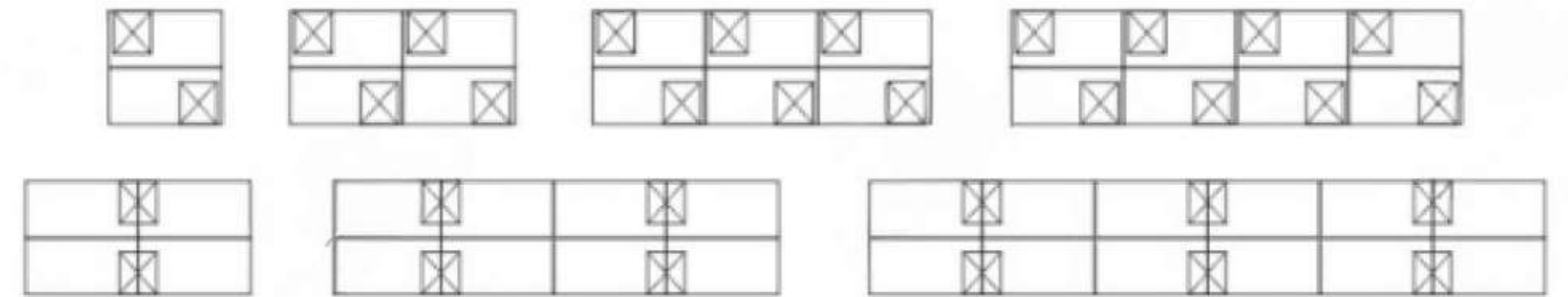

CURVILINEAR : IN LINE - NON SHARING / PAAT TO WACK - SHARING

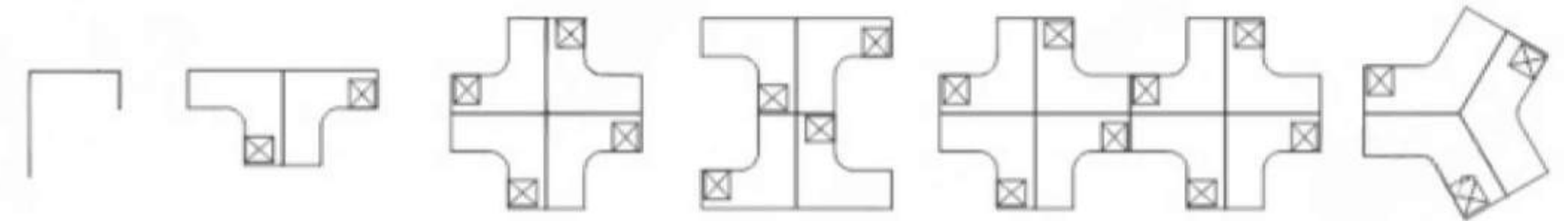

POST - FORMING GRANLEE



Quarter Round Post Formed Profile Available in 25/36mm Thickness Bull Nose Post Formed Profile Available in 25mm Thickness Half Round Post Formed Profile Available in 25/36mm Thickness Reverse Bull Nose Post Formed Profile Available in 25mm Thickness Full Round Post Formed Profile Available in 25/36mm Thickness

INFRASTRUCTURE



The Altendorf Wa8T Panel Saw



The Biesse Automatic Through feed edgbanding machine JADE 335



The Biesse Automatic Through feed edgbanding machine JADE 340



Double Head Multiboring MB 42A



Holzmac Cold Press



Vertical Spindle Moulder With Automatic Feeder



CNC Router
Biesse Rover J GFT



Automatic Post Forming Machine Model PF-2600 (Plc Controlled) With Touch Screen Arrangement

INFRASTRUCTURE



Automatic Sheet Cutting Shearing Machine



Automatic Sheet Cutting Shearing Machine



10 Ton Power Press , Steel Body with electrical with Hand Operation Oil Pump. Bosch Aluminium Cutter



Automatic Pipe Cutting Machine



Mig Welding Machine

ASSOCIATES

NOTES

HÄFELE

CENTURY LAMINATES®
my design. my style.

Merino®

Hettich

GREENLAM™
LAMINATES

OZONE®
FOR A SAFER WORLD

DÖLKEN
A SCHÜCO BRAND

colourFab
Fabrics for the world

JINDAL
STEEL & POWER

TESA
action
FABRICS FOR BONDING & JOINING

ASIS
AAO GHAR SAVARREN

Jowat®
Adhesives

TATA STEEL
We Also Make Tomorrow

Response
Fabric For The World's Best Offices
Fabrics

SAINT-GOBAIN

REHAU
Unlimited Polymer Solutions

EMPORIO
FABRICS

Godrej

Pidilite

ebco®
FURNITURE FITTINGS
Engineered to perform

AS
Asahi India Glass Ltd.

MODIGUARD
Gujrat Guardian Limited

Series of horizontal dashed lines for notes.

ÁGATA LIVING

by Virendra & Co.

📍 7-D, Astley Hall (Near Parade Ground),
Dehra Dun, Uttarakhand - 248001

☎ +91-7900702702, +91-9756437001

🌐 www.agataliving.com

